

## DETAILS

<b>Product Number</b>	C13012_FLARE-MAXI-D
<b>Family</b>	Flare
<b>Type</b>	Lens
<b>Color</b>	clear
<b>Diameter</b>	33,9 + 33,3 mm
<b>Height</b>	16,7 mm
<b>Style</b>	rectang
<b>Optic Material</b>	PMMA
<b>Holder Material</b>	
<b>Fastening</b>	pin, glue
<b>Status</b>	ready
<b>ROHS Compliant</b>	Yes
<b>Date Updated</b>	13/08/2014



## OPTICAL PROPERTIES

LED	Viewing Angle	Light Beam	Efficiency	cd/lm	connector
LUXEON H50-2	(simulated) 10+65		(simulated) 92 %	(simulated) 3.300	-
LH351Z	98+13 degrees		94 %	2.200	-
Oslon Square EC	99+14 degrees		94 %	2.000	-
MK-R	100+23 degrees		92 %	1.200	-
XM-L2	101+17 degrees		94 %	1.900	-
LUXEON MZ	101+16 degrees		94 %	1.900	-
LUXEON T	102+13 degrees		92 %	1.800	-
LUXEON M	102+25 degrees		94 %	1.400	-
LUXEON TX	103+13 degrees		93 %	2.060	-
Z5M1	104 + 14 degrees		94 %	2.100	-
LUXEON A	104+12 degrees		94 %	2.100	-
Oslon Square PC	104+12 degrees		94 %	2.000	-
LUXEON Rebel ES	104+13 degrees		94 %	2.000	-
XP-G2	106+14 degrees		94 %	2.000	-
NCSxx19B	107+13 degrees		94 %	2.100	-
XM-L	110+15 degrees		94 %	1.700	-
NS9x383	110+16 degrees		93 %	1.500	-
XP-G	115+15 degrees		94 %	1.900	-
NVSxx19B	116+13 degrees		94 %	1.700	-
XT-E	117+14 degrees		94 %	1.900	-
XP-L	119+16 degrees		94 %	1.480	-
Oslon SSL 150	128+13 degrees		94 %	2.000	-

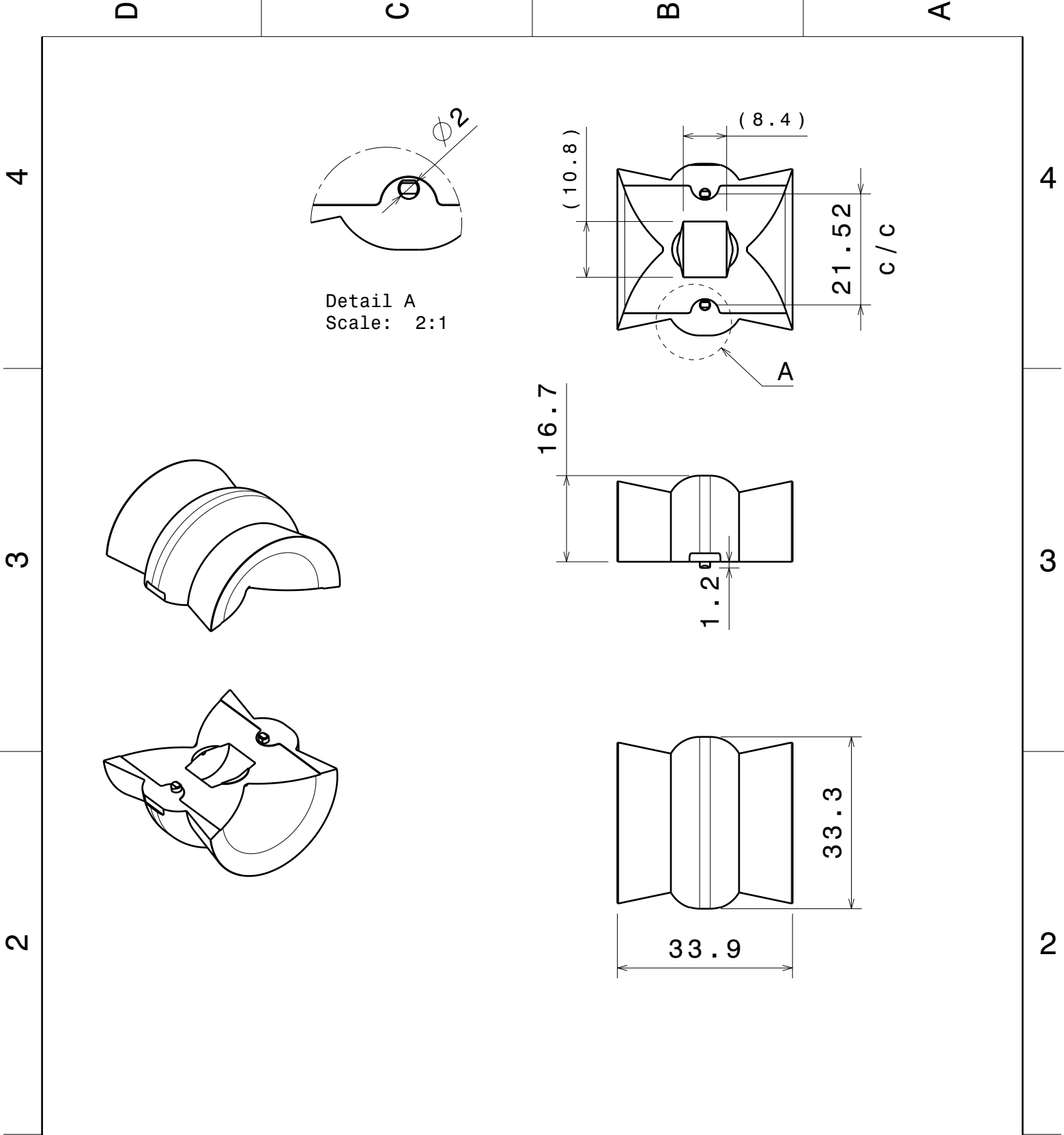

This drawing is our property. It can't be reproduced or communicated without our written agreement.



Ledil Oy  
Salorankatu 10  
FIN 24240 SALO  
Finland

**DRAWING TITLE**

**Datasheet FLARE-MAXI-D Lens**

**DRAWN BY**  
ah

**DATE**  
7.11.2013

**CHECKED BY**  
pv

**DATE**  
7.11.2013

**SIZE**  
A4

**DRAWING NUMBER**  
C13012

**REV**  
1

**DESIGNED BY**  
hh

**DATE**  
6.4.2012

**SCALE**

1:1

**WEIGHT (g)**

**SHEET**

1/1

D

A

Luminaire: LEDiL Oy C13012\_FLARE-MAXI-D\_(LH351Z) Eff.94.1%  
Lamps: 1 x SAMSUNG\_LH351Z\_90.8111lm@250mA\_P=0.748076W\_I=249.9mA

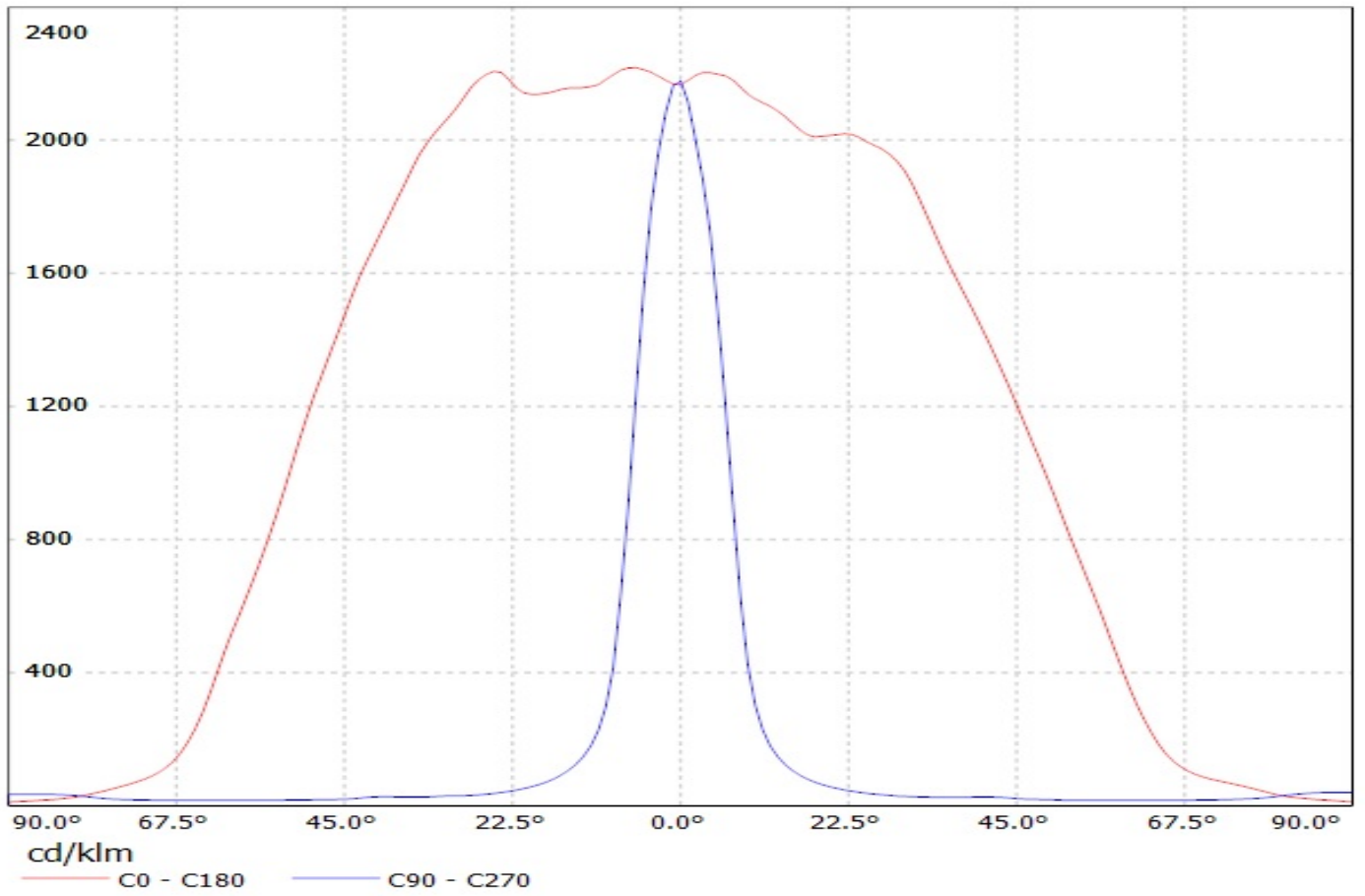

Luminaire: Ledil Oy C13012\_FLARE-MAXI-D (Osam Square EC 66lm @250mA) Efficiency=94%  
Lamps: 1 x Osam Square EC 66lm @250mA

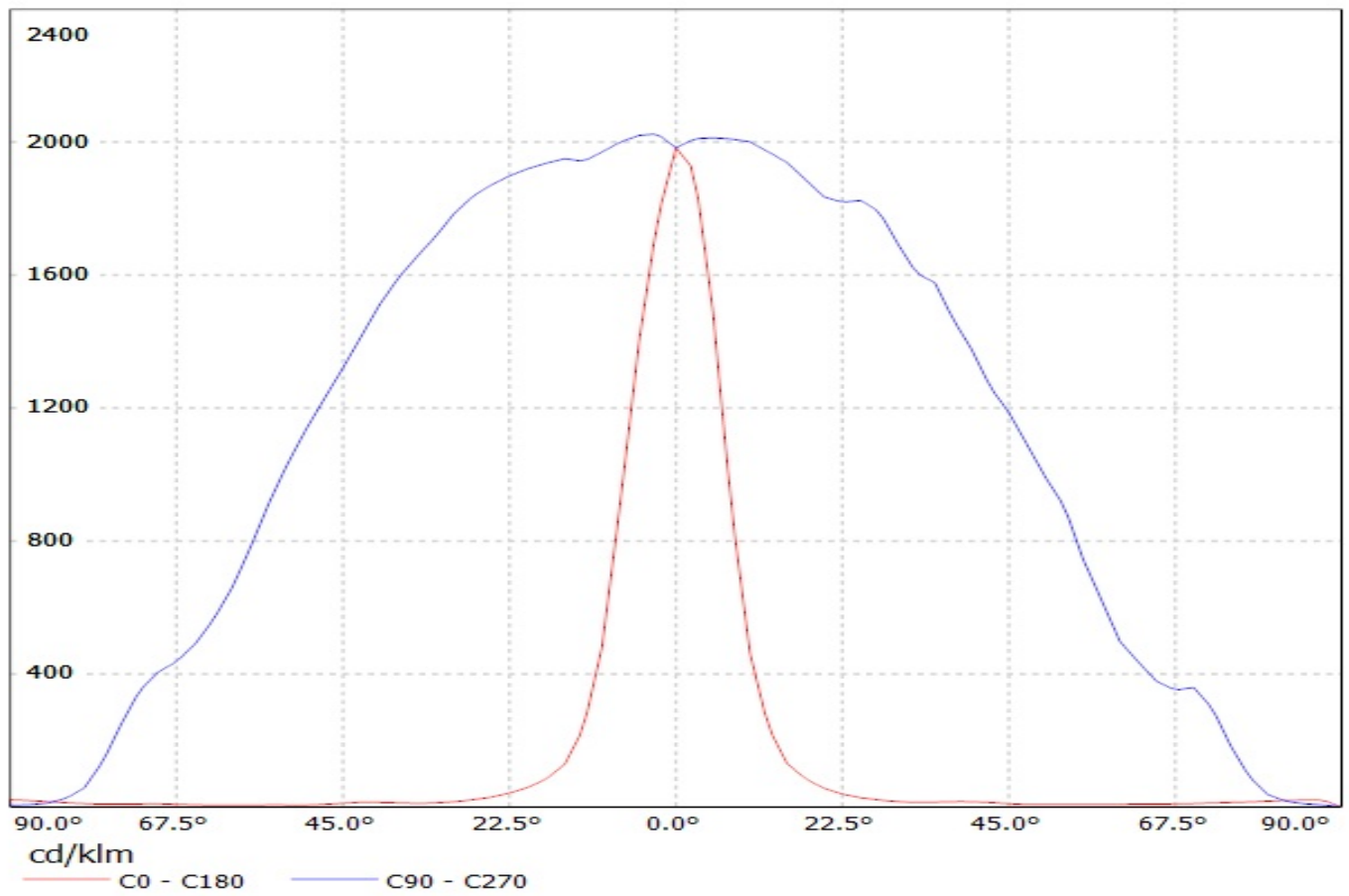

# LEDiL Oy C13012\_FLARE-MAXI-D\_(MKR) Eff.92.2% / LDC (Linear)

Luminaire: LEDiL Oy C13012\_FLARE-MAXI-D\_(MKR) Eff.92.2%  
Lamps: 1 x CREE\_MKR (368.505lm@250mA)

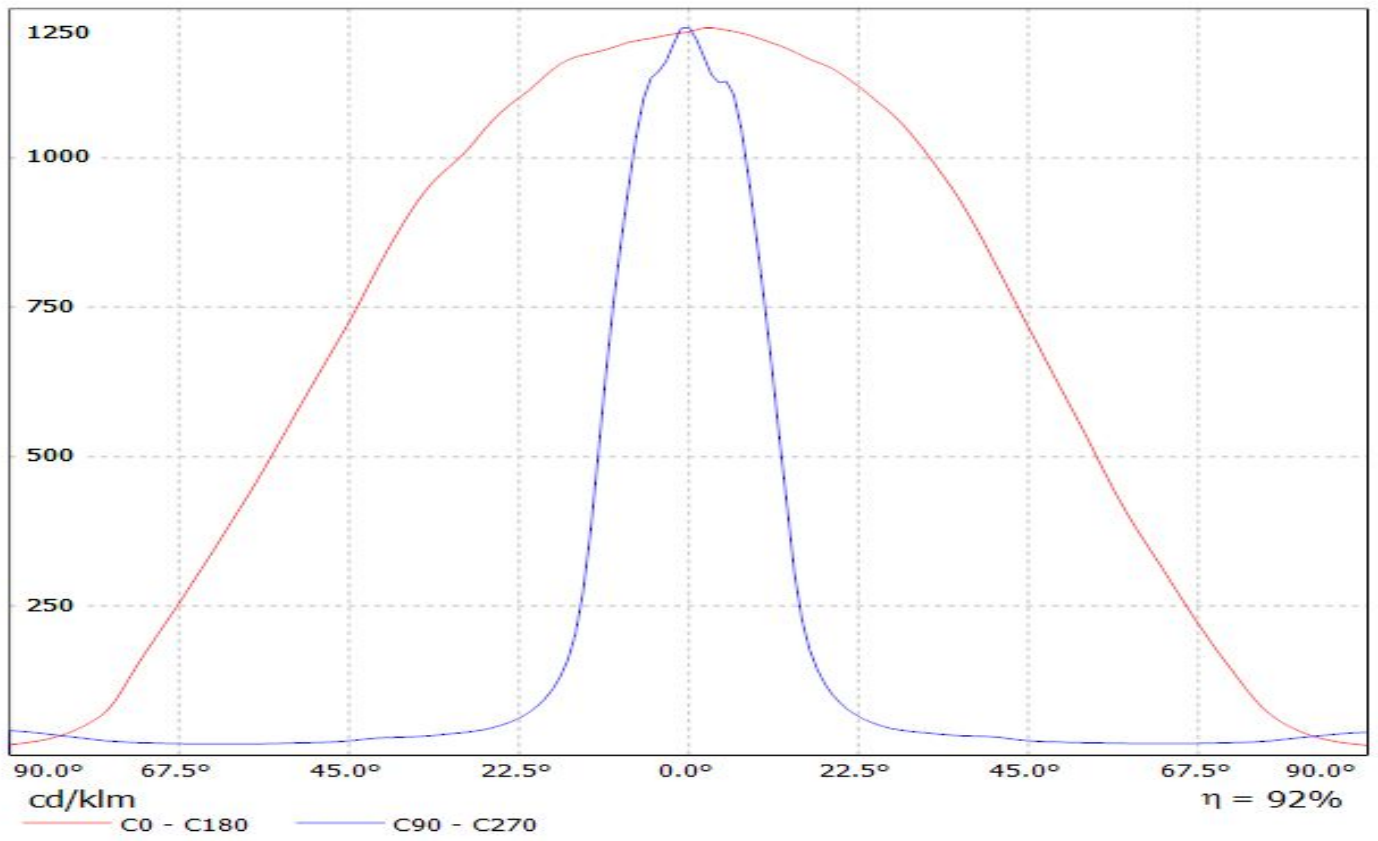

Luminaire: LEDil Oy C13012\_FLARE-MAXI-D\_(XM-L2) Efficiency=94%  
Lamps: 1 x Cree XM-L2 (XMLBWT-0-7B4-T30-0L-0001) 91lm @ 250mA CCT=3200K P=0.7W I=250mA

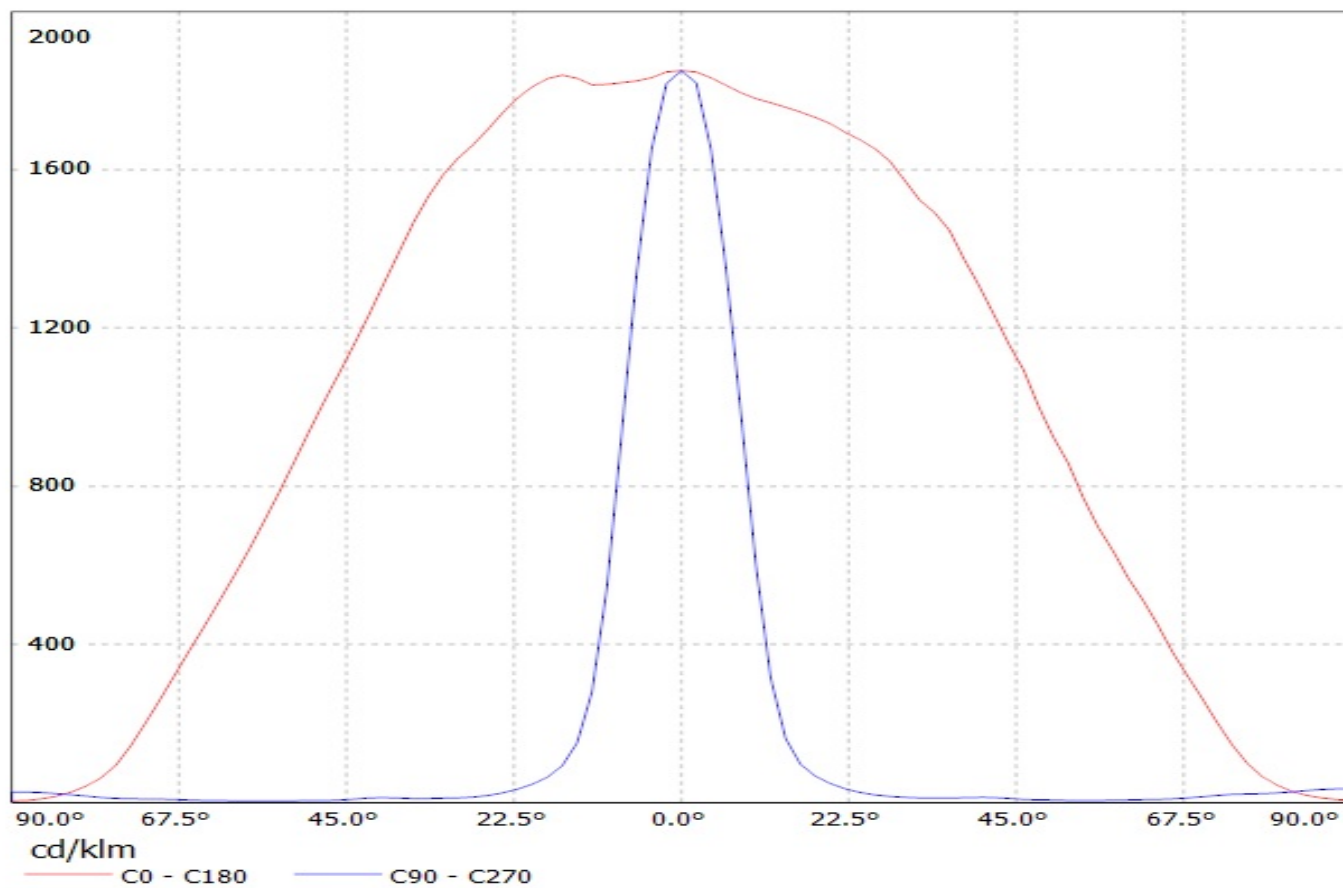

Luminaire: LEDil Oy C13012\_FLARE-MAXI-D\_(Luxeon\_MZ) Efficiency=94%  
Lamps: 1 x Philips Lumileds Luxeon MZ (389lm @ 250mA) CCT=3800K P=2.8W I=250mA

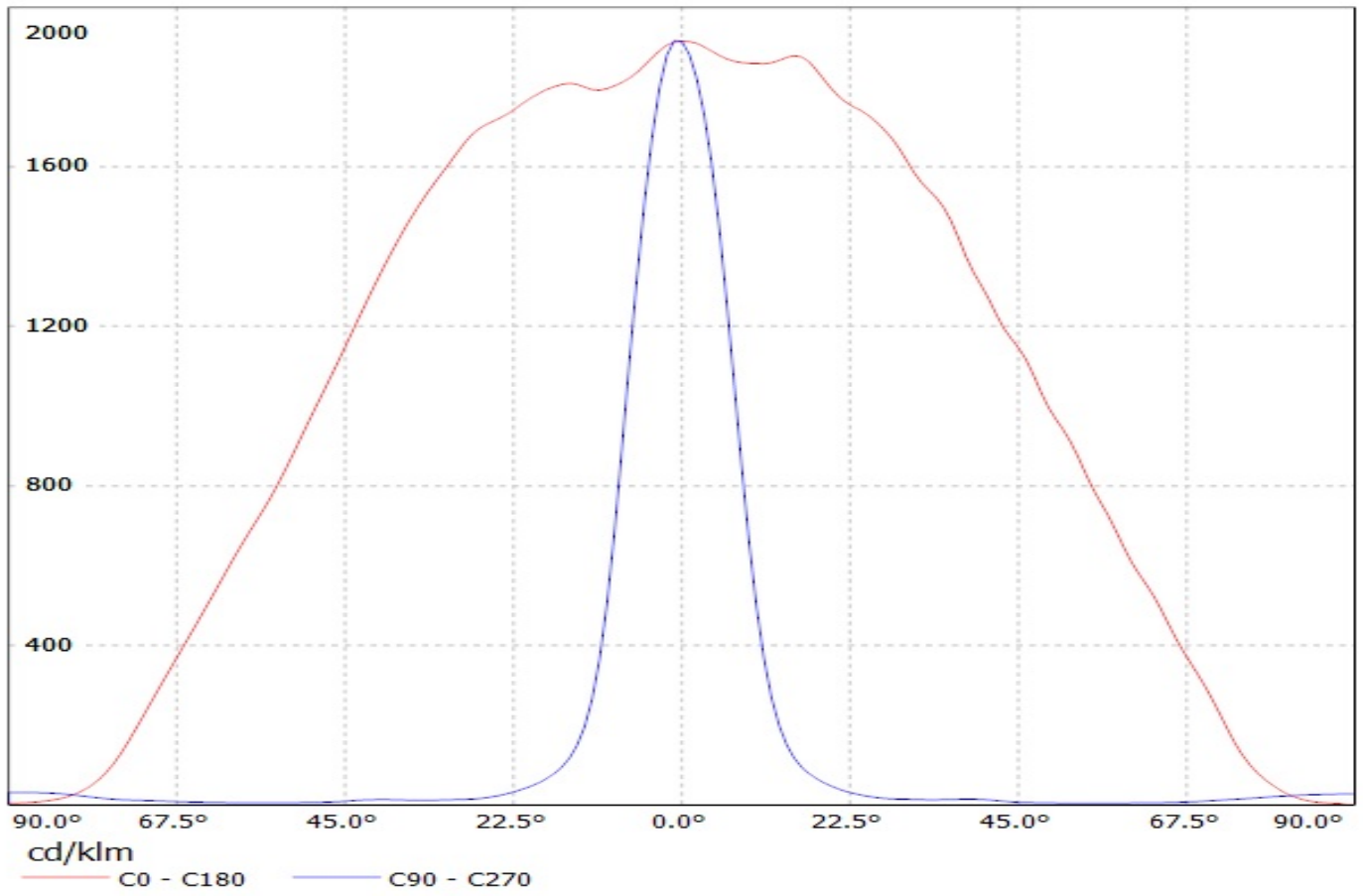

Luminaire: LEDiL Oy C13012\_FLARE-MAXI-D\_(LUXEON\_T) Eff.92.0%  
Lamps: 1 x LUXEON T (74lm@250mA)

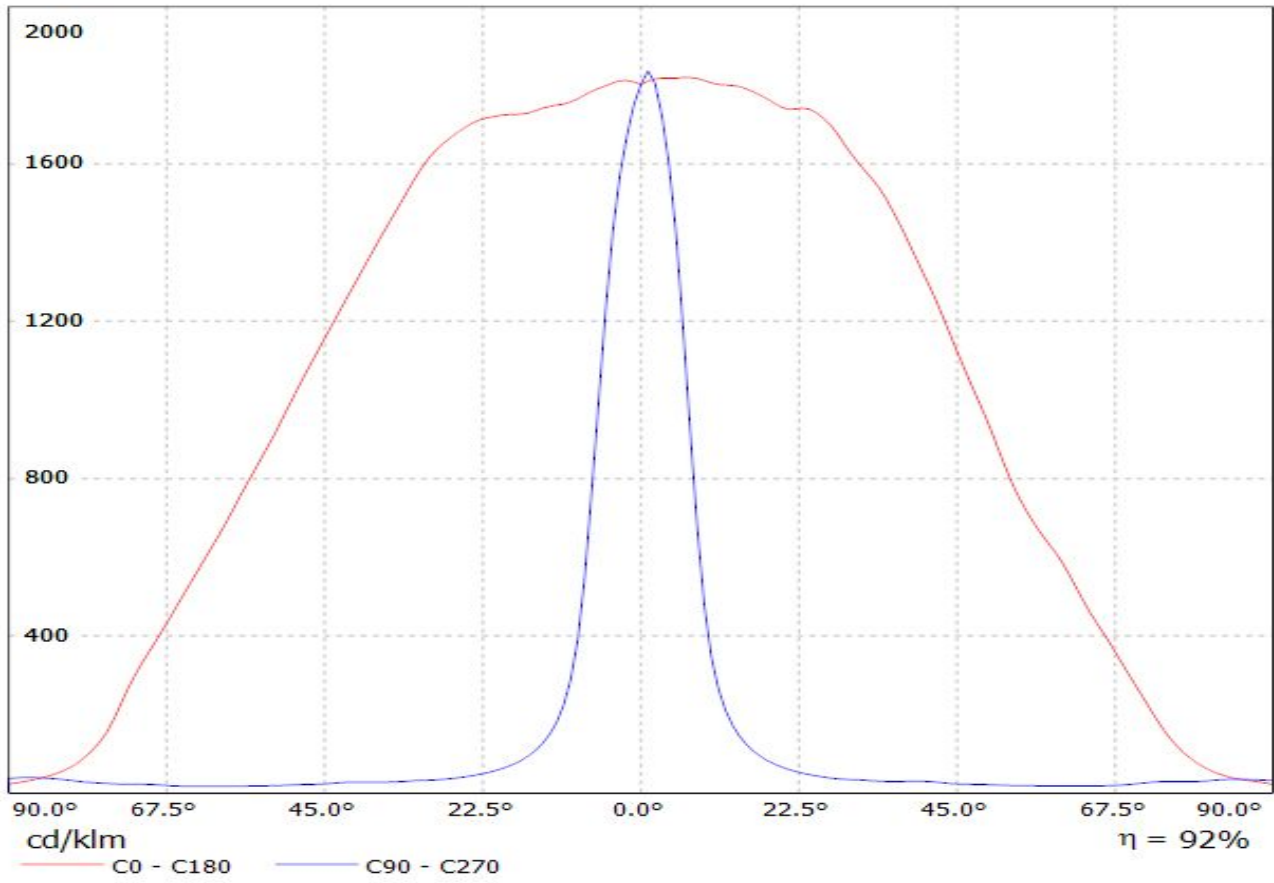



Luminaire: Ledil Oy C13012\_FLARE-MAXI-D (Luxeon M 342lm @250mA) Efficiency=94%  
Lamps: 1 x Luxeon M 342lm @250mA

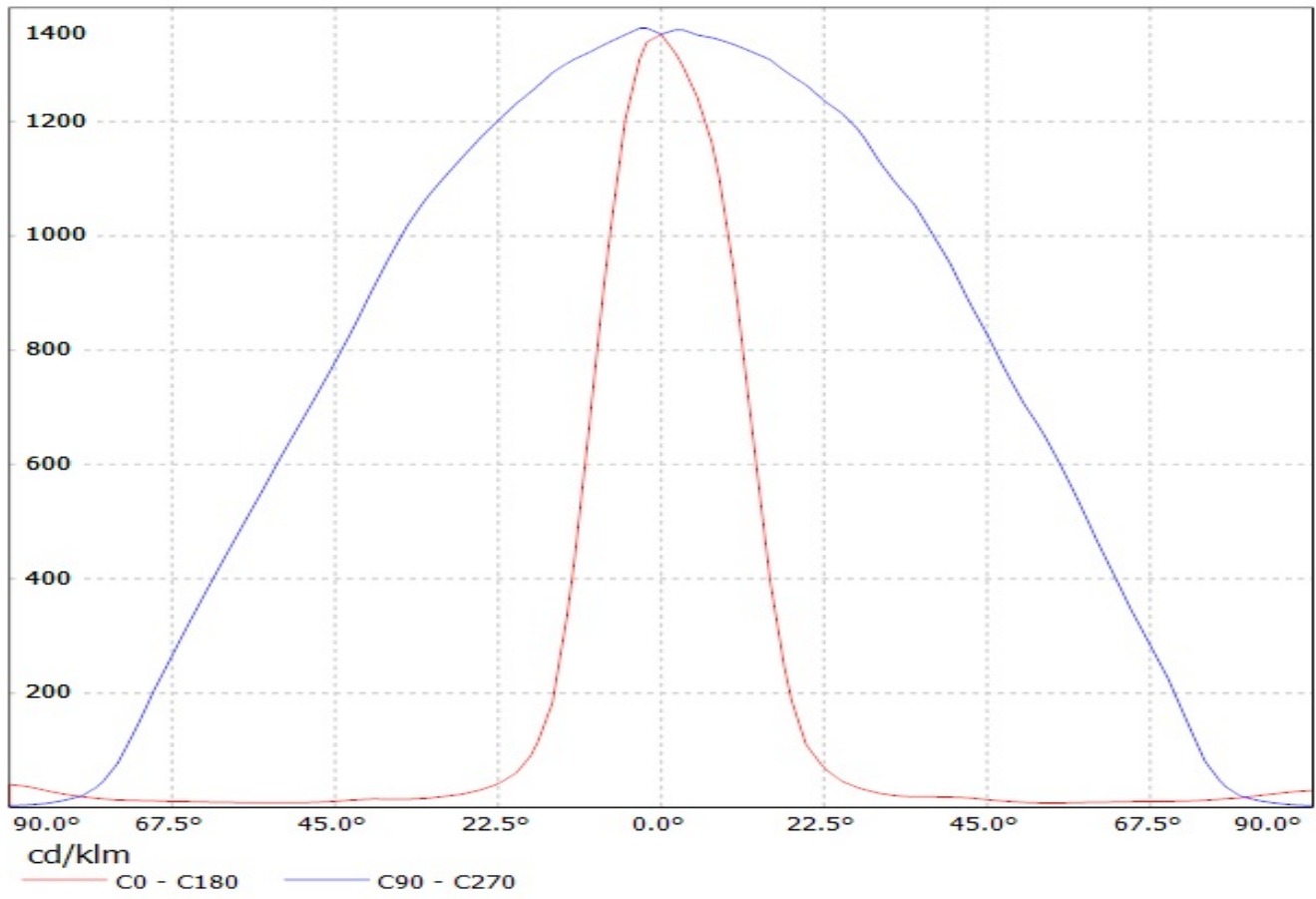

Luminaire: LEDiL Oy C13012\_FLARE-MAXI-D (Luxeon\_TX)  
Lamps: 1 x Luxeon\_TX\_(L1T2-3585)\_80.1801lm@250mA\_CCT=3500K\_P=0.731482W\_I=249.9mA

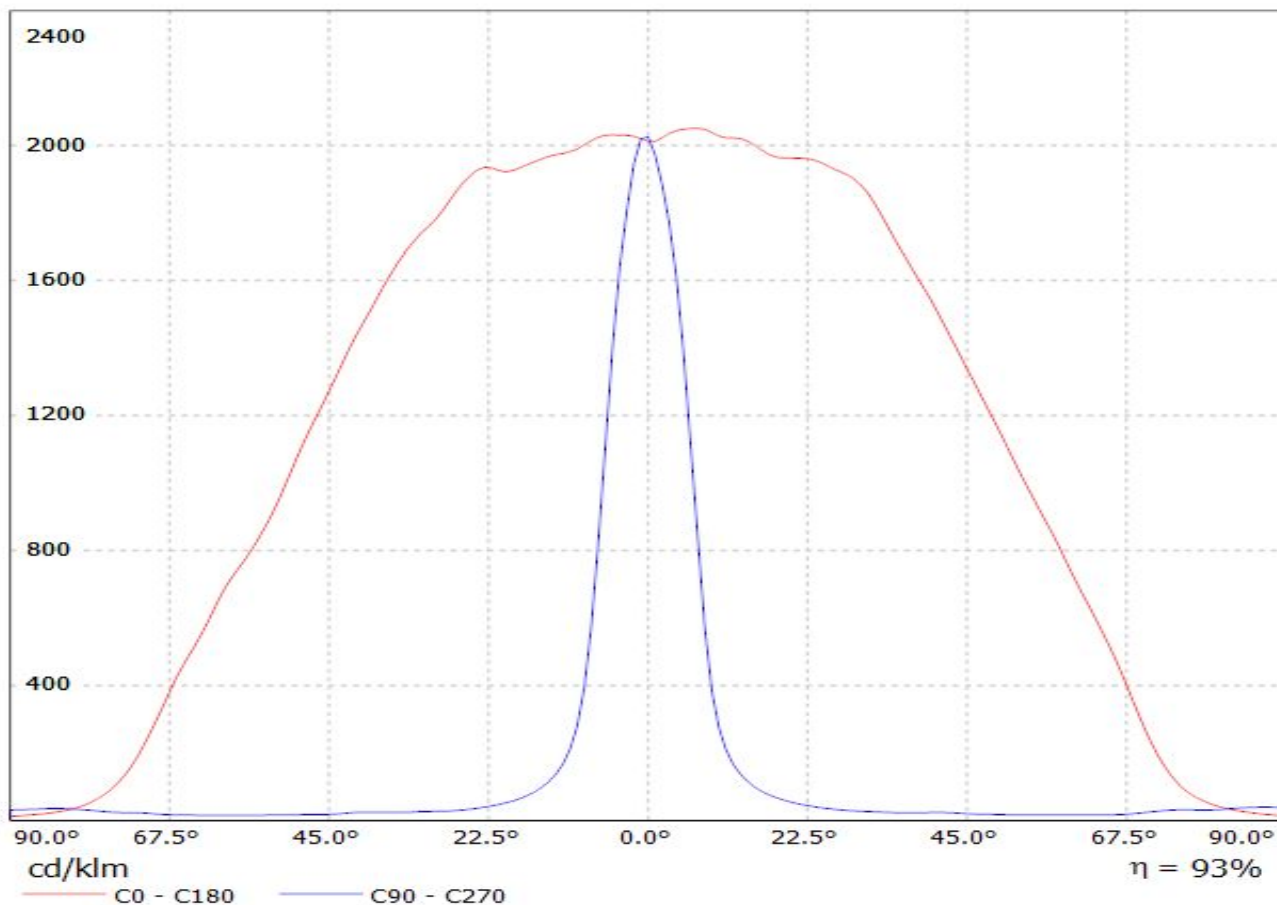

Luminaire: LEDil Oy C13012\_FLARE-MAXI-D\_(Z5M1) Efficiency=94%  
Lamps: 1 x Seoul Z5M1 (SZ5M1-W0-C8/W1-A5-G) 108lm @ 250mA CCT=9100K P=0.8W I=250mA

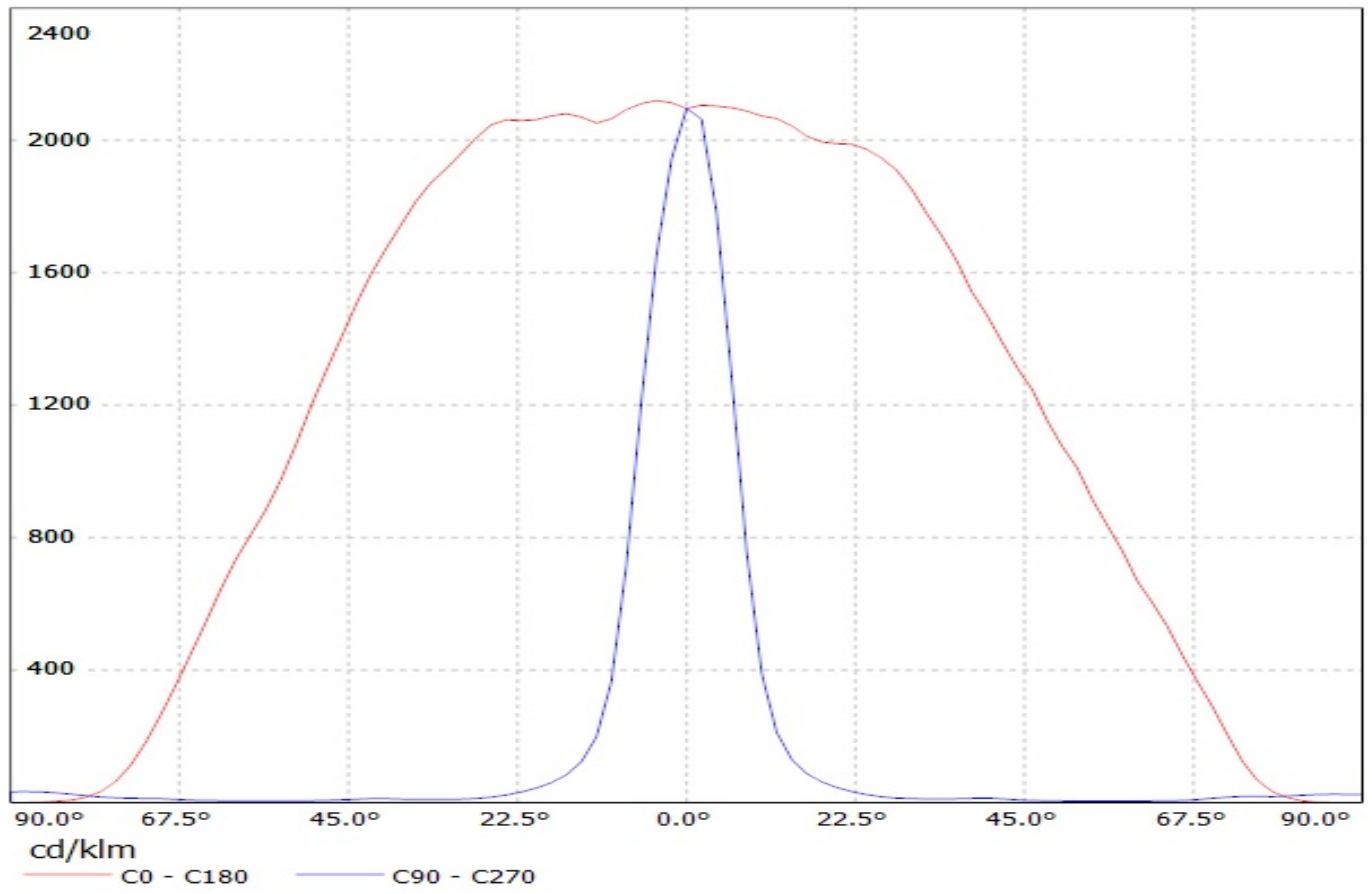

Luminaire: Ledil oy C13012\_FLARE-MAXI-D (Luxeon A 64lm @ 250mA) Efficiency=94%  
Lamps: 1 x Luxeon A 64lm @ 250mA

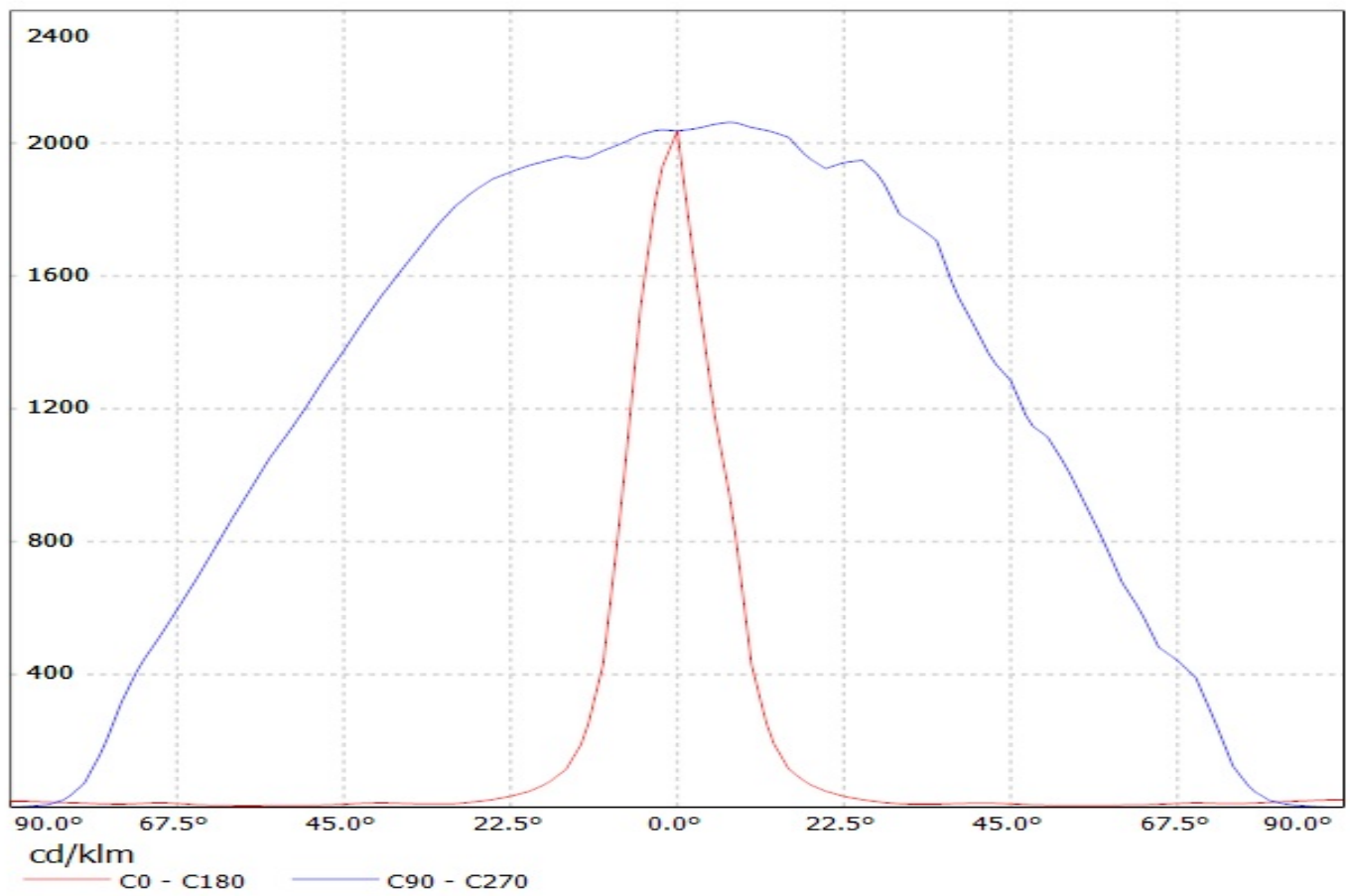

Luminaire: Ledil Oy C13012\_FLARE-MAXI-D (Osram Square PC 88lm @ 250mA) Efficiency=94%  
Lamps: 1 x Osram Square PC 88lm @ 250mA

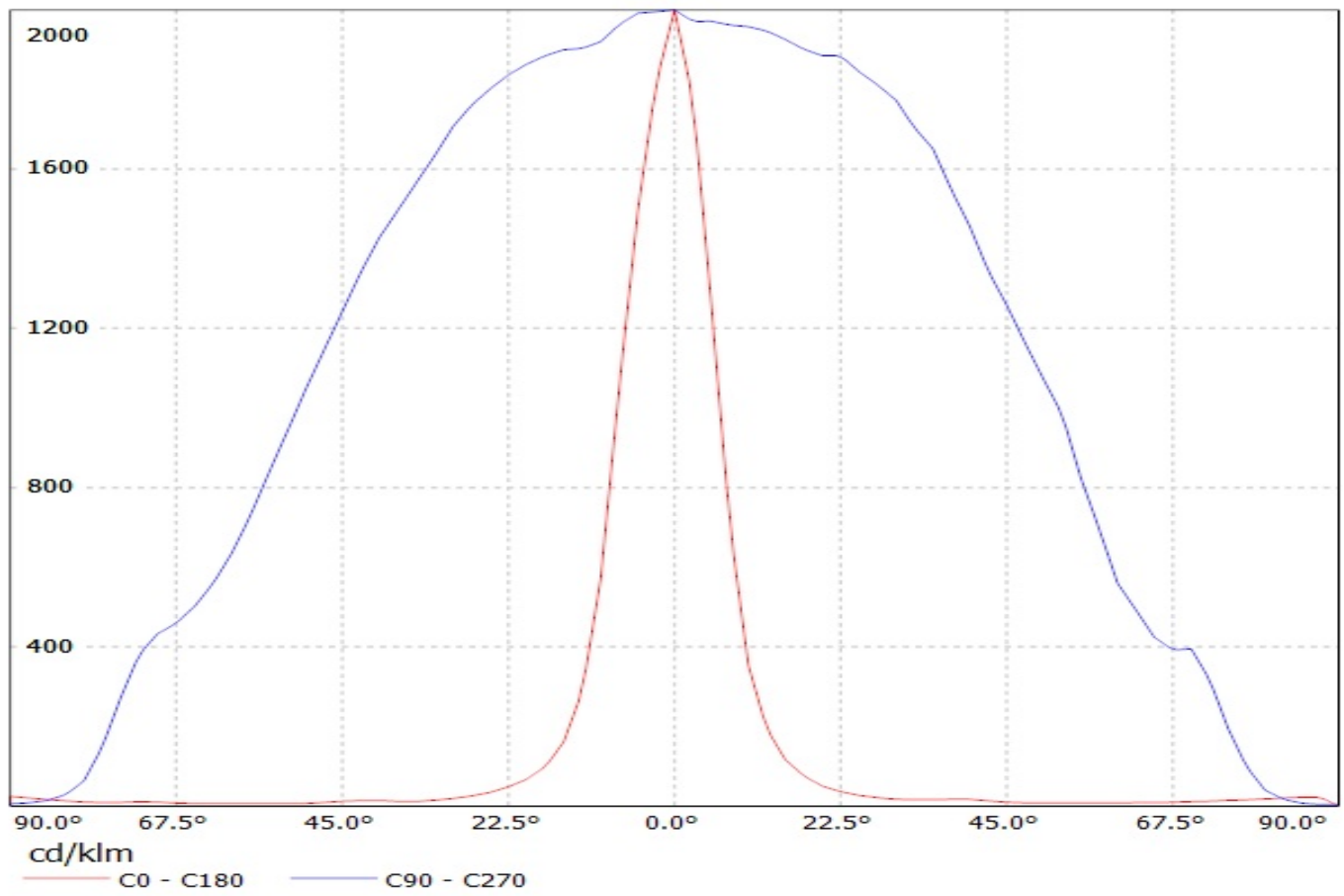

Luminaire: Ledil Oy C13012\_FLARE-MAXI-D (Luxeon RE-ES 92lm @ 250mA) Efficiency=94%  
Lamps: 1 x Luxeon RE-ES 92lm @ 250mA

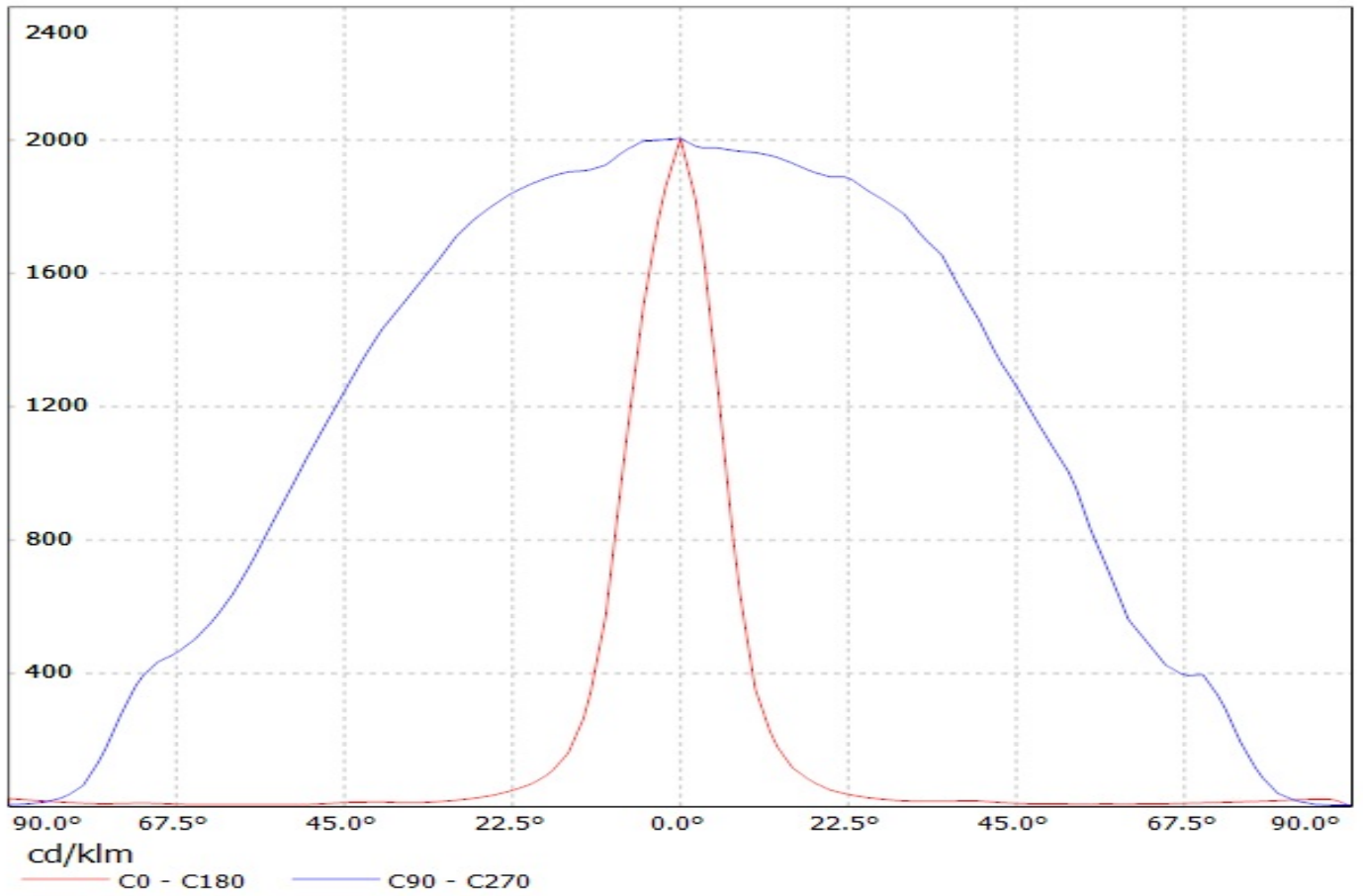

Luminaire: Ledil Oy C13012\_FLARE-MAXI-D (Cree XP-G2 98lm @ 250mA) Efficiency=94%  
Lamps: 1 x Cree XP-G2 98lm @ 250mA CCT=6596K P=0,75W I=250mA

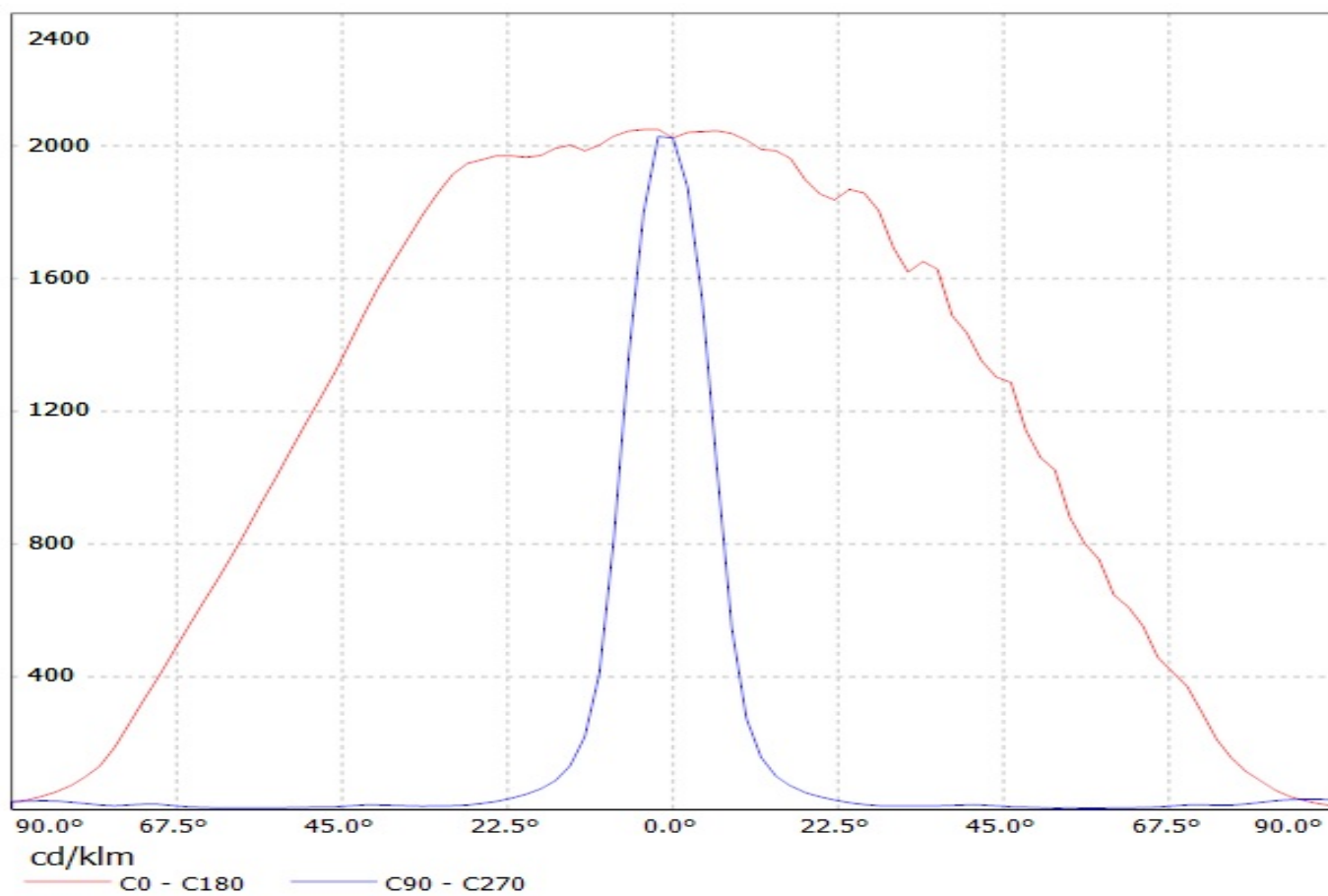

Luminaire: Ledil Oy C13012\_FLARE-MAXI-D\_(NCSxx19B) Efficiency=94%  
Lamps: 1 x Nichia NSCxx19B (NCSL119BE) 88lm @ 250mA CCT=3000K P=0.8W I=250mA

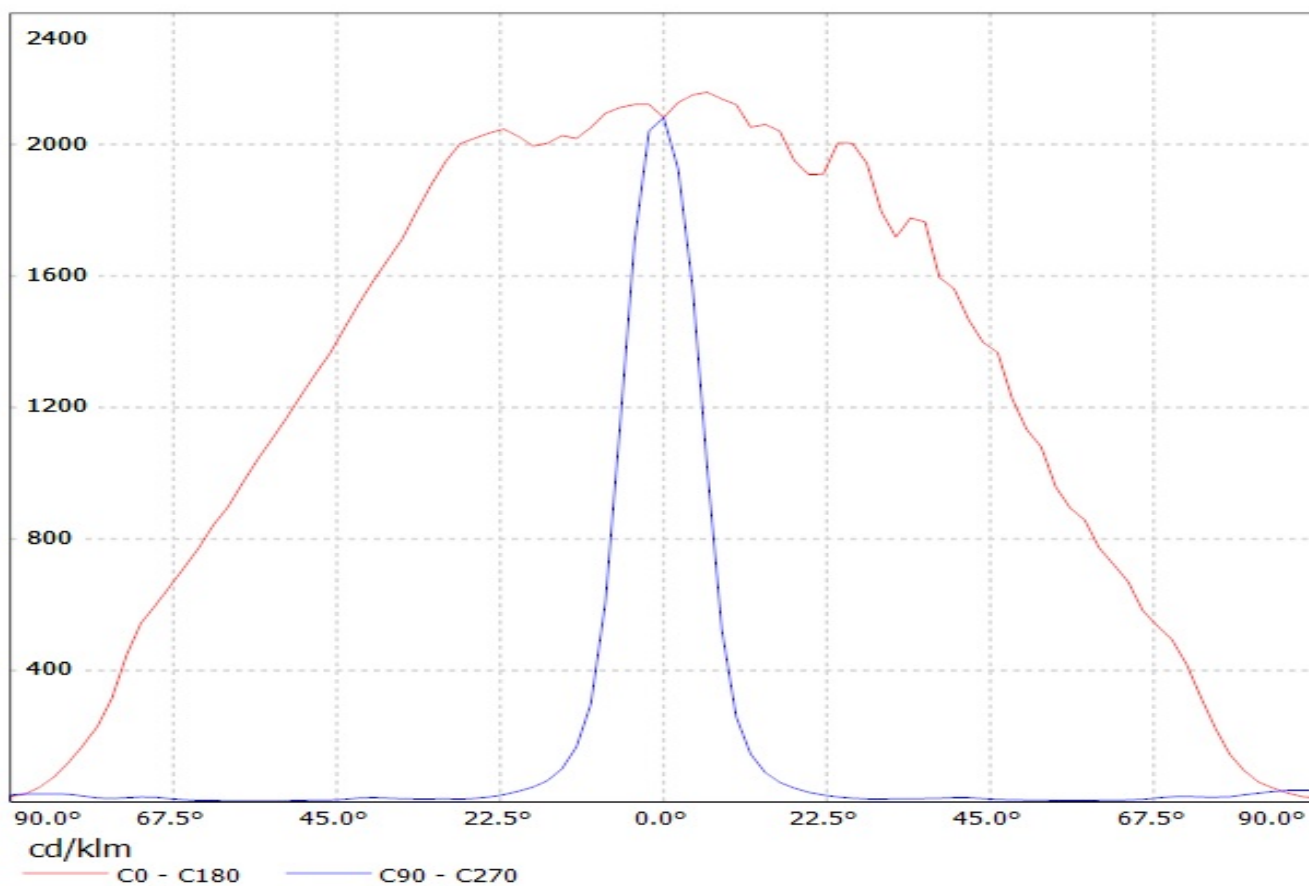



Luminaire: Ledil Oy C13012\_FLARE-MAXI-D (Cree XM-L 97lm @ 250mA) Efficiency=94%  
Lamps: 1 x Cree XM-L 97lm @ 250mA

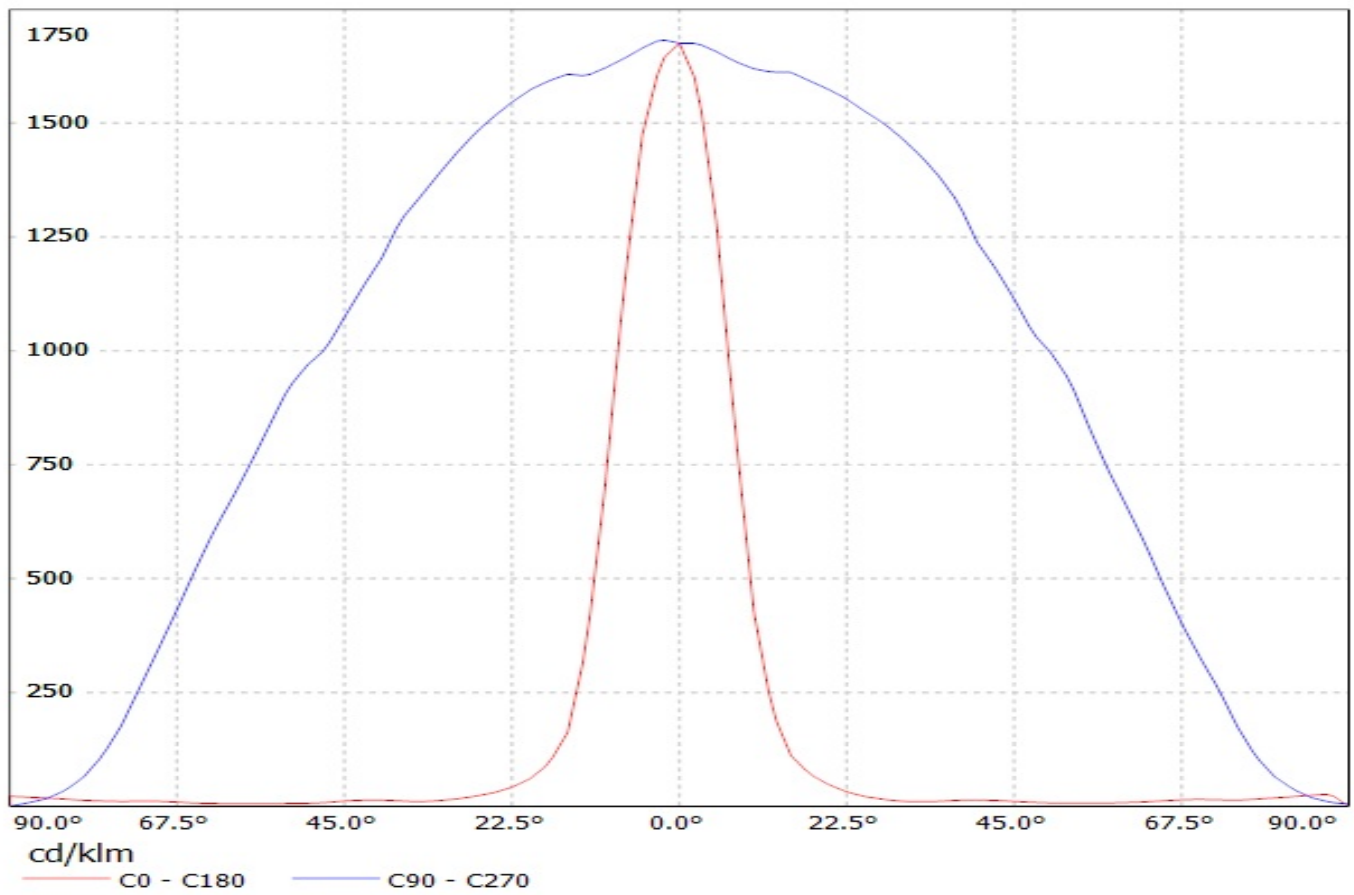

Luminaire: LEDiL Oy C13012\_FLARE-MAXI-D Eff.93.2%  
Lamps: 1 x Nichia NS9x383(107.656lm@250mA)

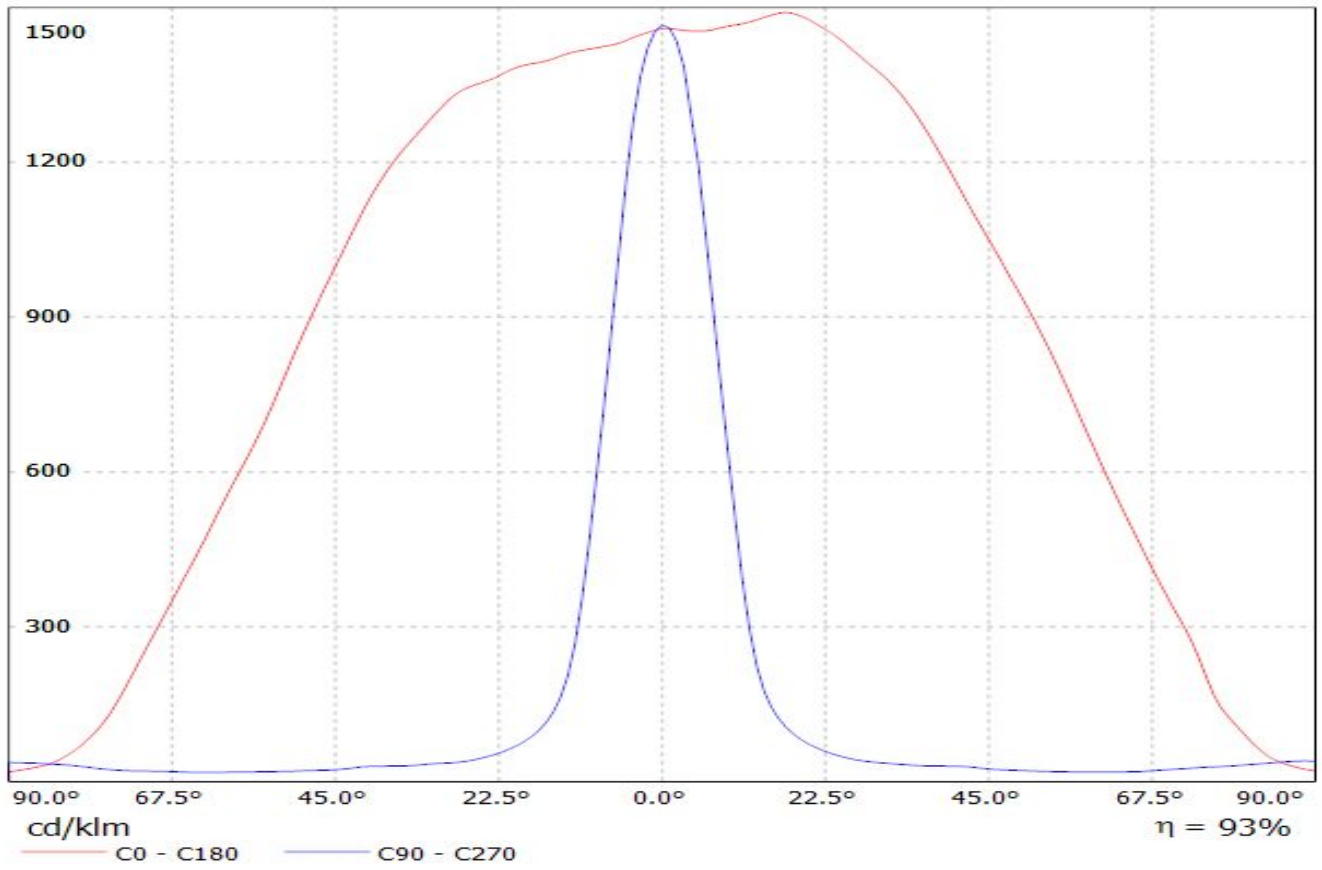

Luminaire: Ledil Oy C13012\_FLARE-MAXI-D (Cree XP-G 70lm @ 250mA) Efficiency=94%  
Lamps: 1 x Cree XP-G 70lm @ 250mA

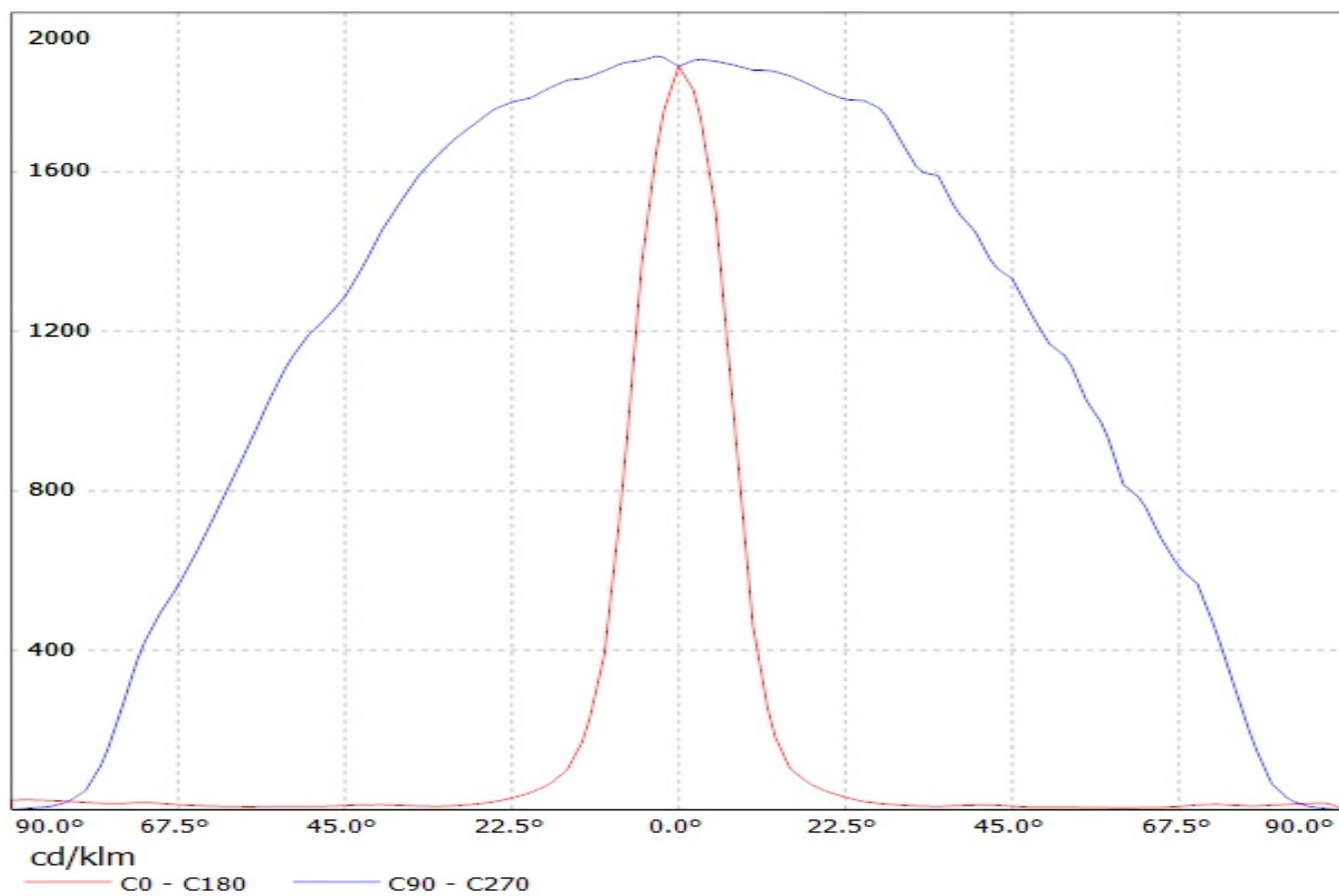

Luminaire: Ledil Oy C13012\_FLARE-MAXI-D (Nichia 219B 103lm @ 250mA) Efficiency=94%  
Lamps: 1 x Nichia 219B 103lm @ 250mA

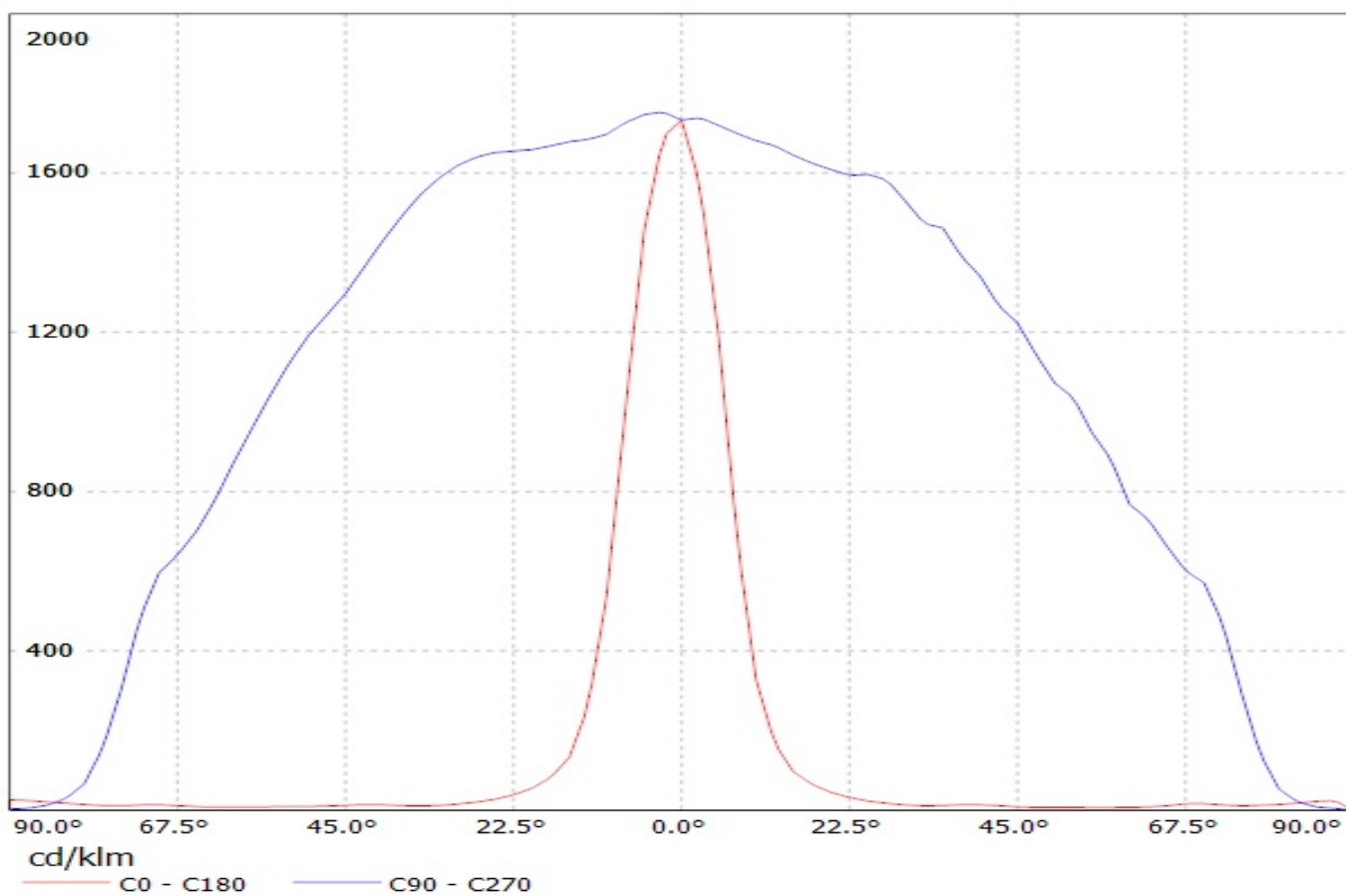

Luminaire: Ledil Oy C13012\_FLARE-MAXI-D (Cree XT-E 98lm @ 250mA) Efficiency=94%  
Lamps: 1 x Cree XT-E 98lm @ 250mA

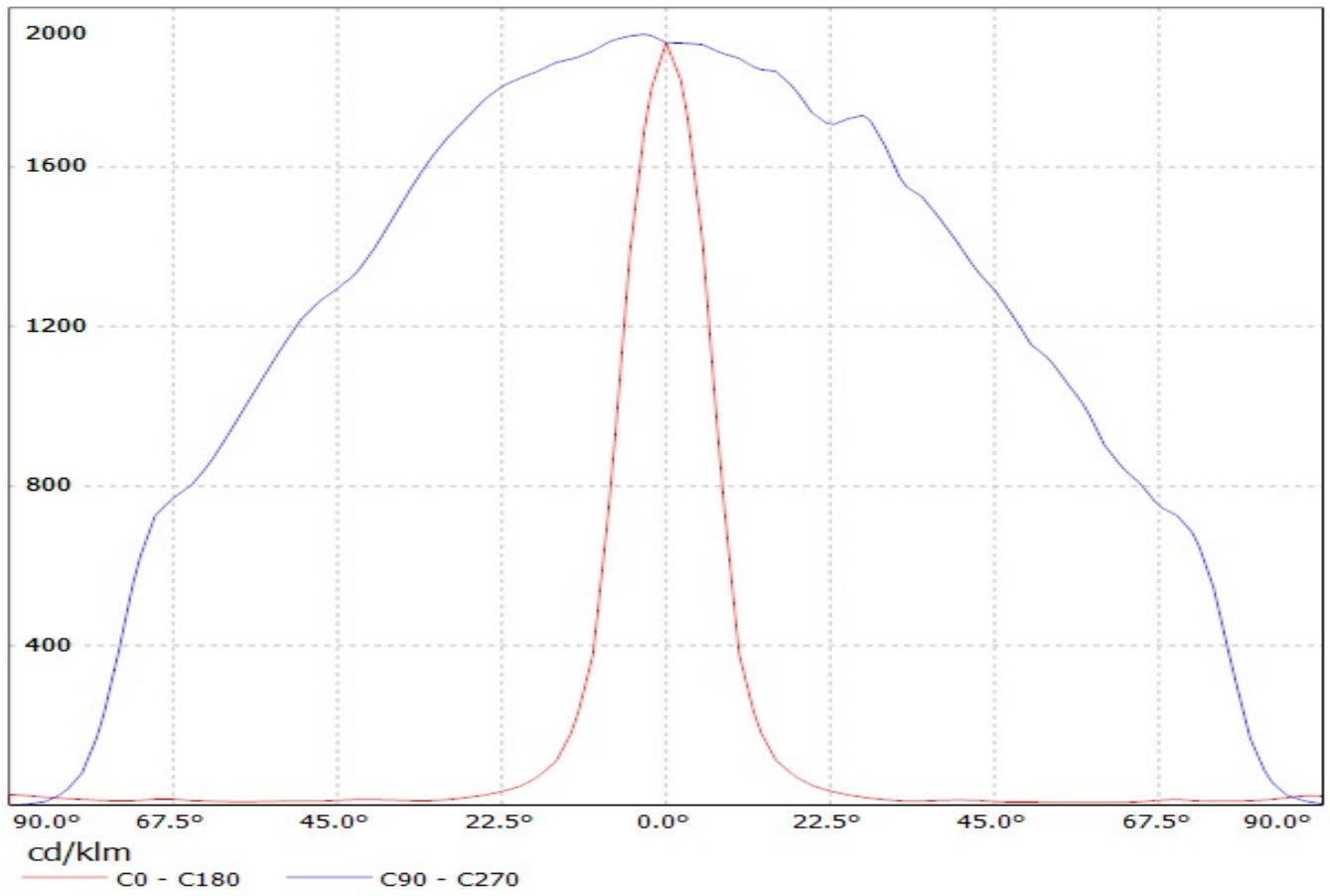

Luminaire: LEDiL Oy C13012\_FLARE-MAXI-D\_(XP-L)  
Lamps: 1 x Cree\_XP-L\_130lm@250mA\_P=0.73723W\_I=249.9mA

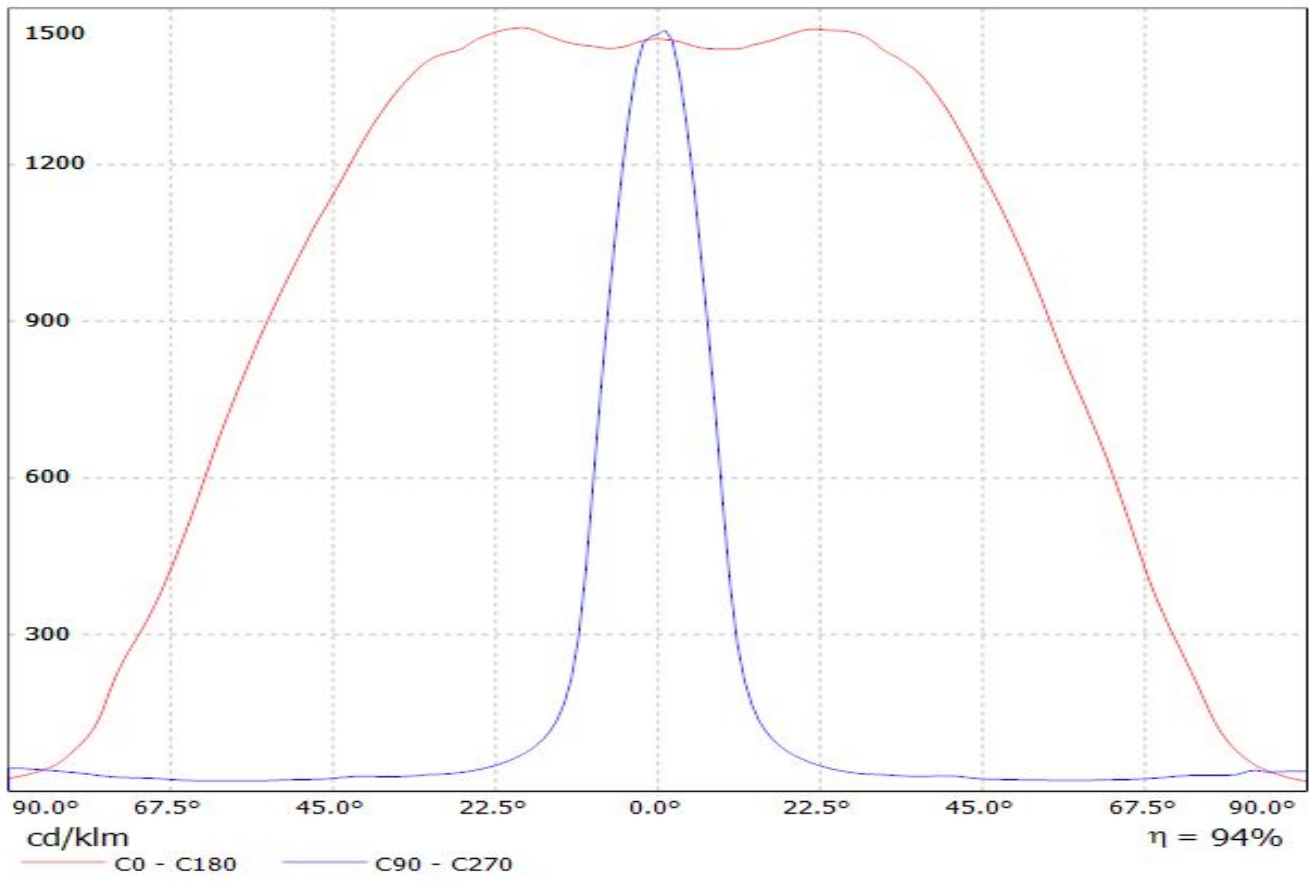

Luminaire: LEDil Oy C13012\_FLARE-MAXI-D\_(Oslon\_SSL\_150)  
Lamps: 1 x Osram Oslon SSL 150 (78.52lm @ 250mA) P=0.7W I=250mA

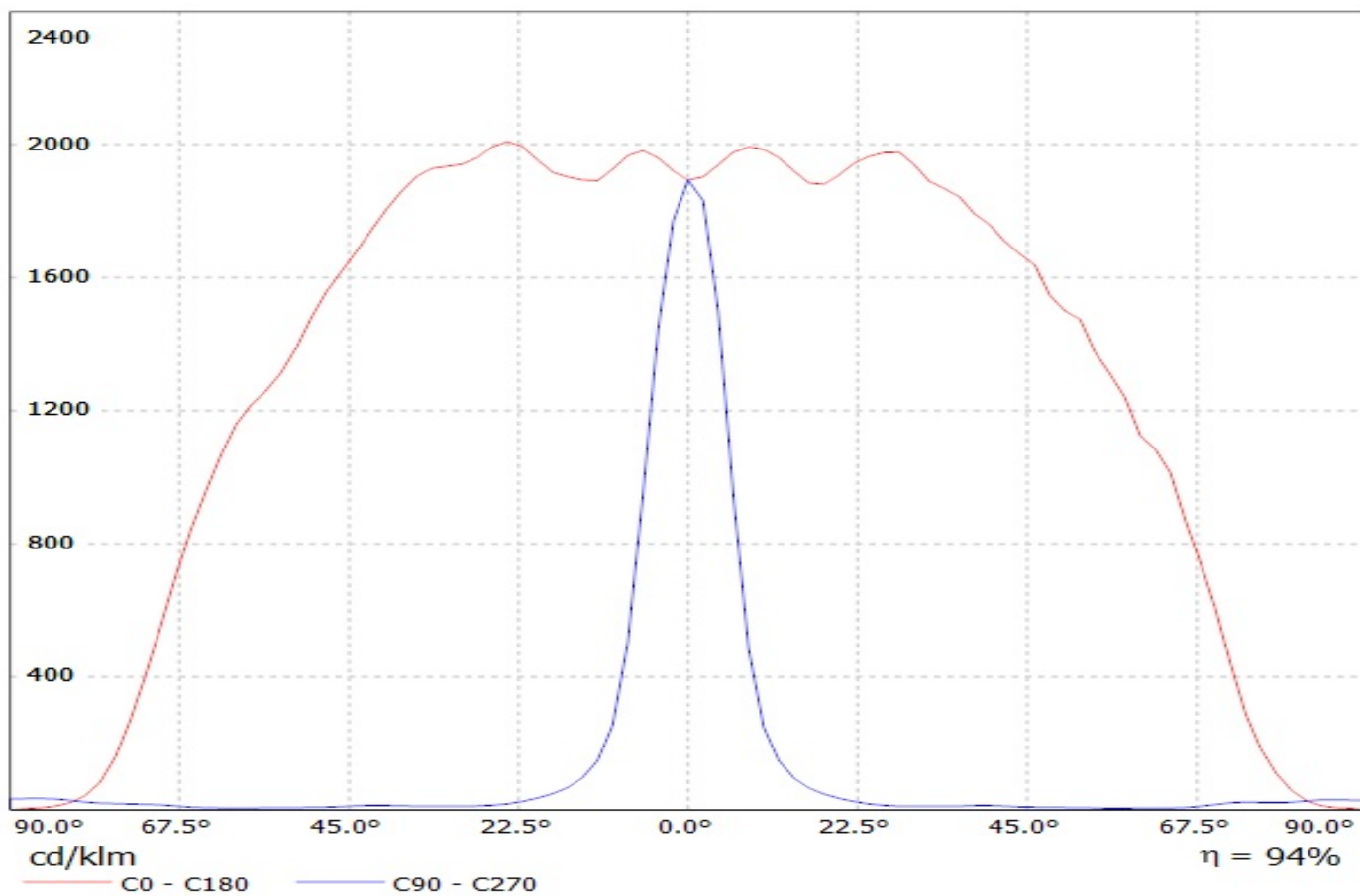

Luminaire: LEDiL Oy C13012\_FLARE-MAXI-D\_(LH351Z) Eff.94.1%  
Lamps: 1 x SAMSUNG\_LH351Z\_90.8111lm@250mA\_P=0.748076W\_I=249.9mA

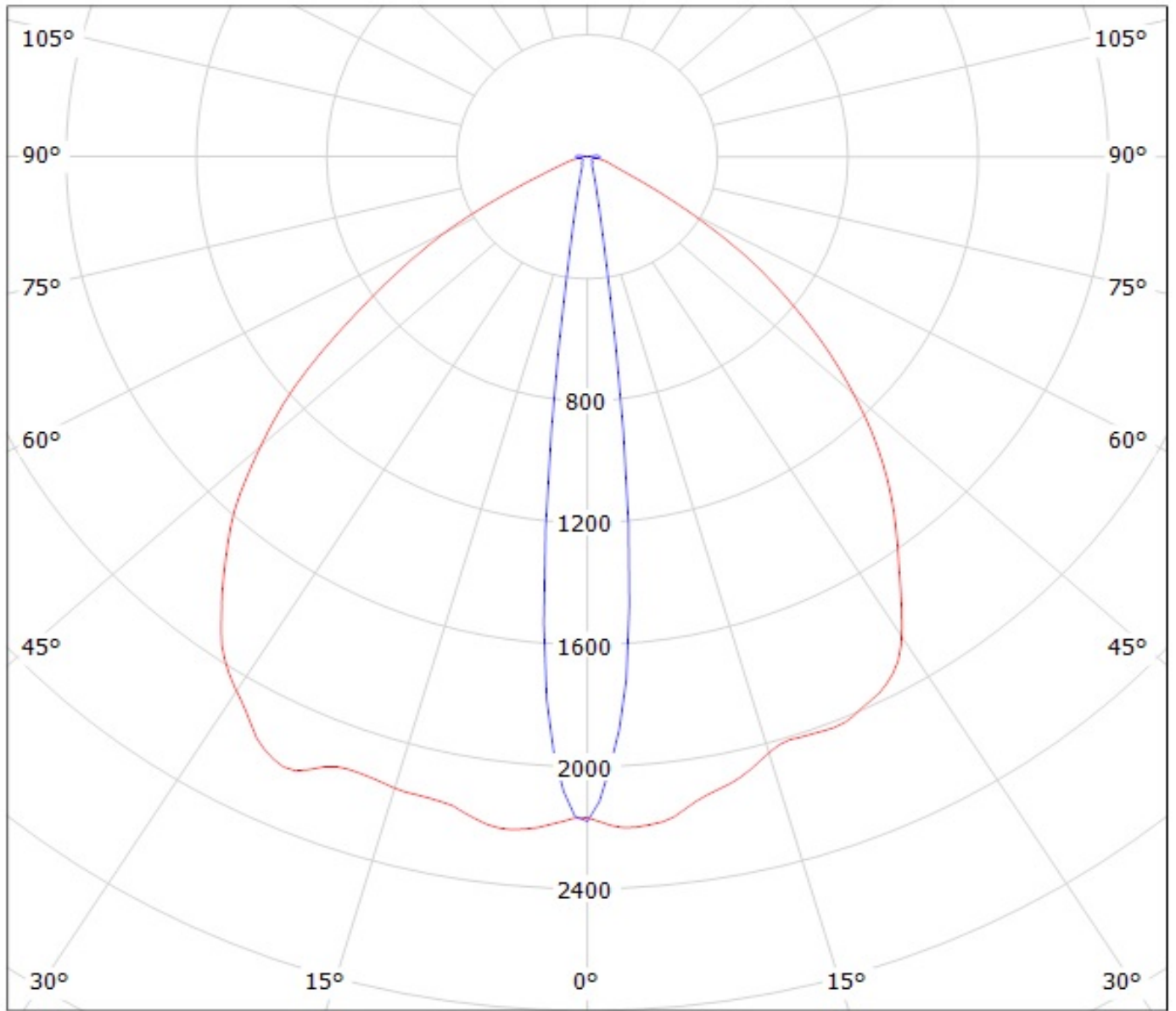

cd/klm

— C0 - C180    — C90 - C270



Luminaire: Ledil Oy C13012\_FLARE-MAXI-D (Osam Square EC 66lm @250mA) Efficiency=94%  
Lamps: 1 x Osam Square EC 66lm @250mA

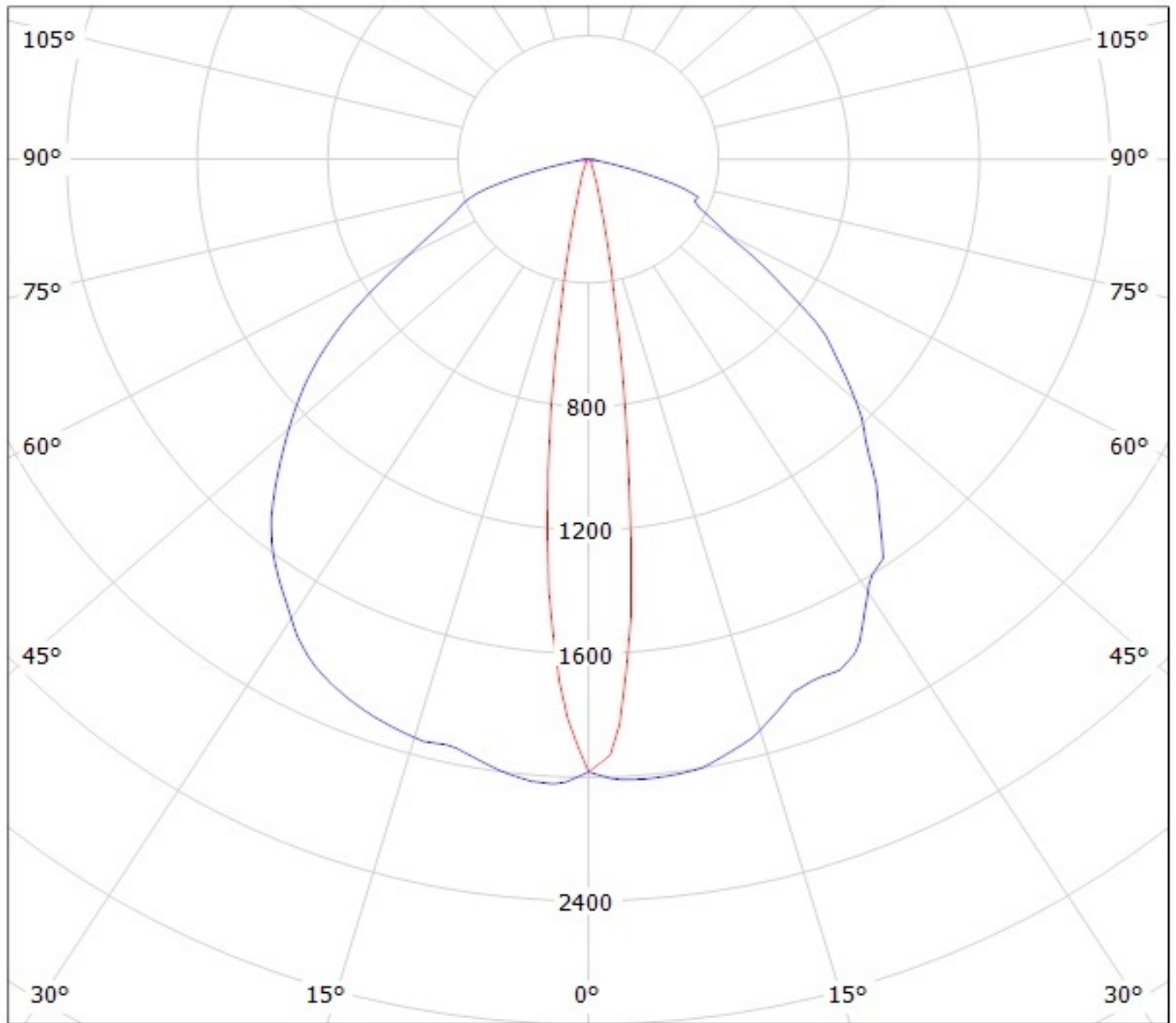

cd/klm

— C0 - C180 — C90 - C270

# LEDiL Oy C13012\_FLARE-MAXI-D\_(MKR) Eff.92.2% / LDC (Polar)

Luminaire: LEDiL Oy C13012\_FLARE-MAXI-D\_(MKR) Eff.92.2%

Lamps: 1 x CREE\_MKR (368.505lm@250mA)

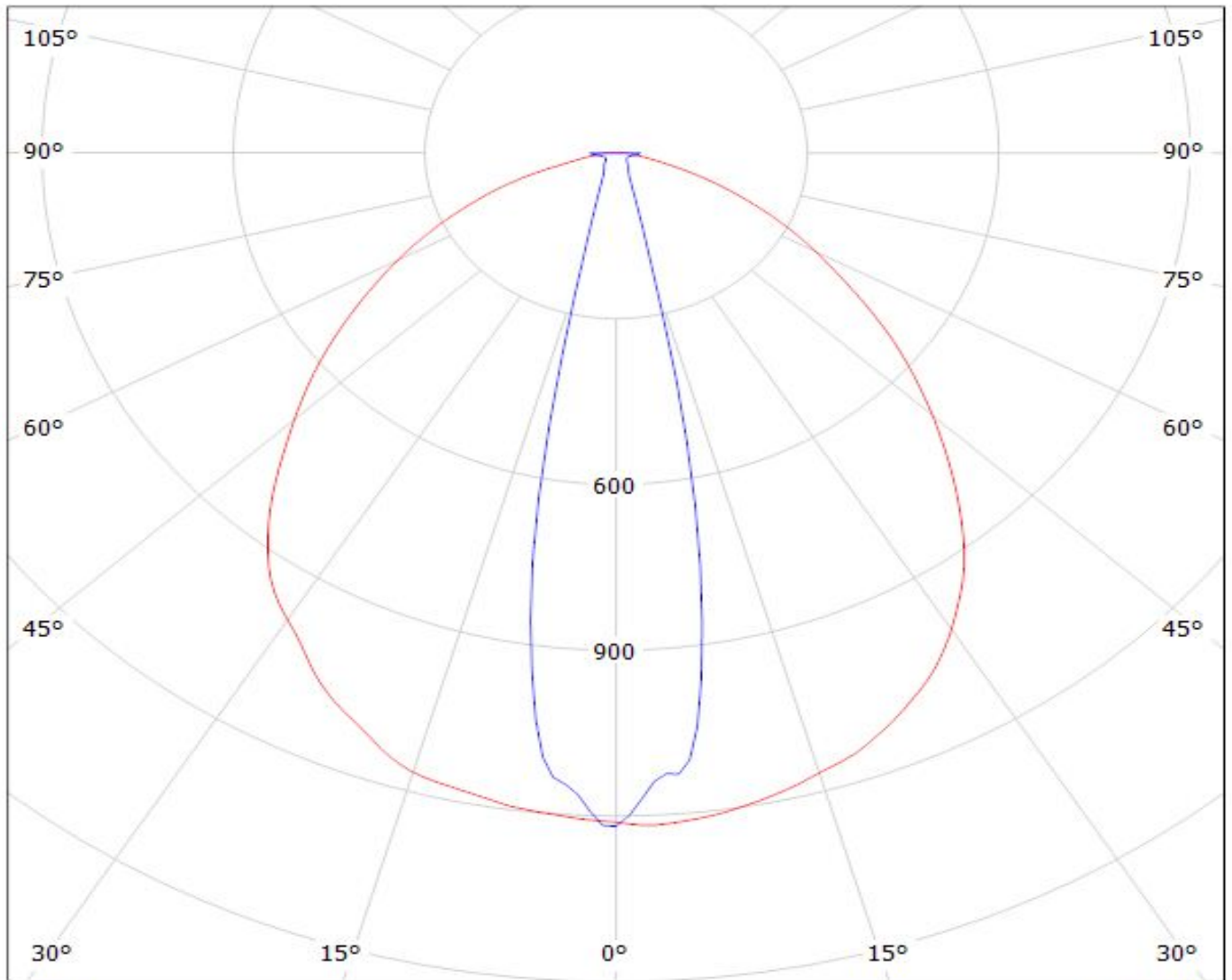

cd/klm

$\eta = 92\%$

— C0 - C180

— C90 - C270

Luminaire: LEDil Oy C13012\_FLARE-MAXI-D\_(XM-L2) Efficiency=94%

Lamps: 1 x Cree XM-L2 (XMLBWT-0-7B4-T30-0L-0001) 91lm @ 250mA CCT=3200K P=0.7W I=250mA

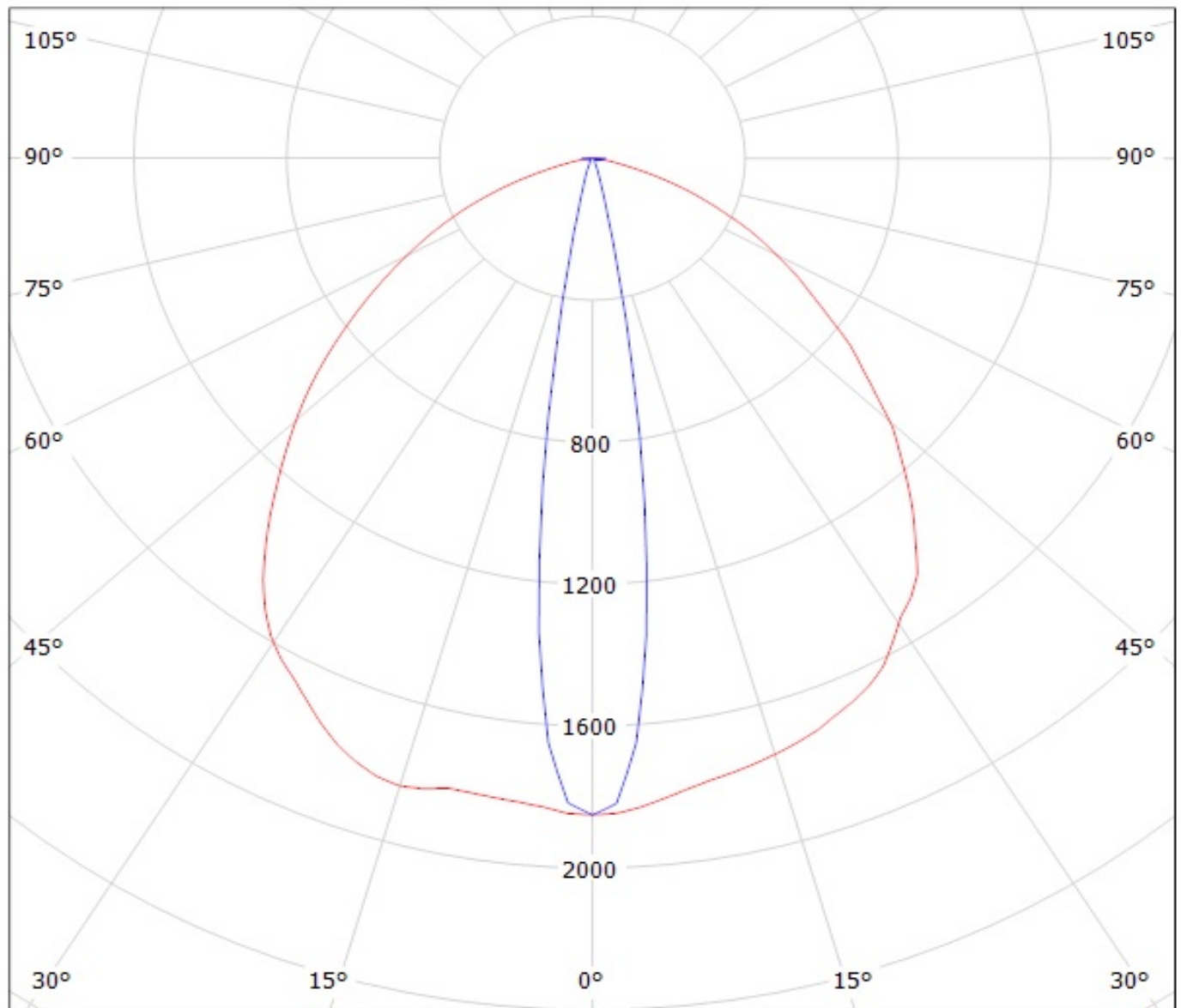

cd/klm

— C0 - C180

— C90 - C270

Luminaire: LEDil Oy C13012\_FLARE-MAXI-D\_(Luxeon\_MZ) Efficiency=94%  
Lamps: 1 x Philips Lumileds Luxeon MZ (389lm @ 250mA) CCT=3800K P=2.8W I=250mA

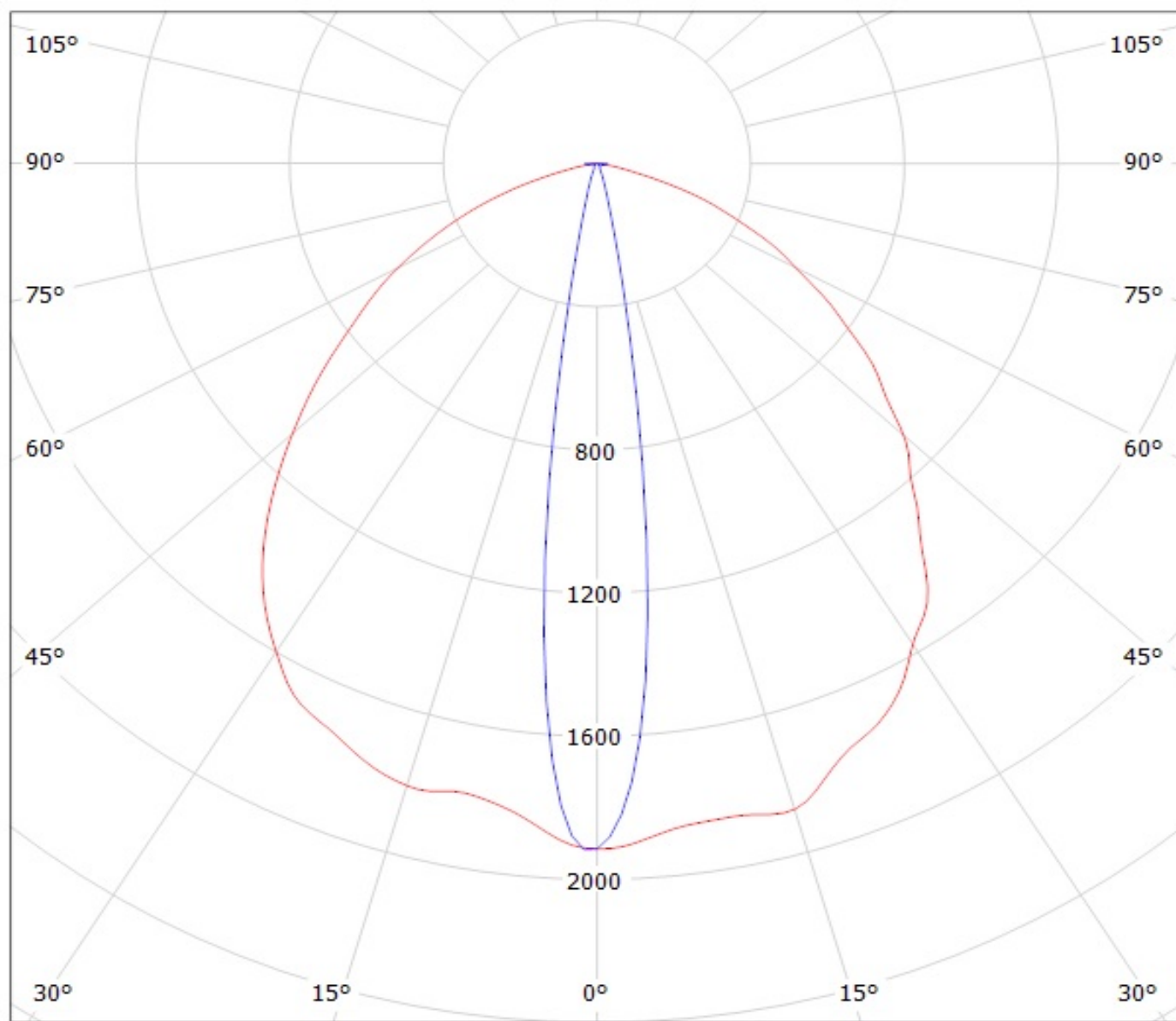

cd/klm

— C0 - C180    — C90 - C270

Luminaire: LEDiL Oy C13012\_FLARE-MAXI-D\_(LUXEON\_T) Eff.92.0%  
Lamps: 1 x LUXEON T (74lm@250mA)

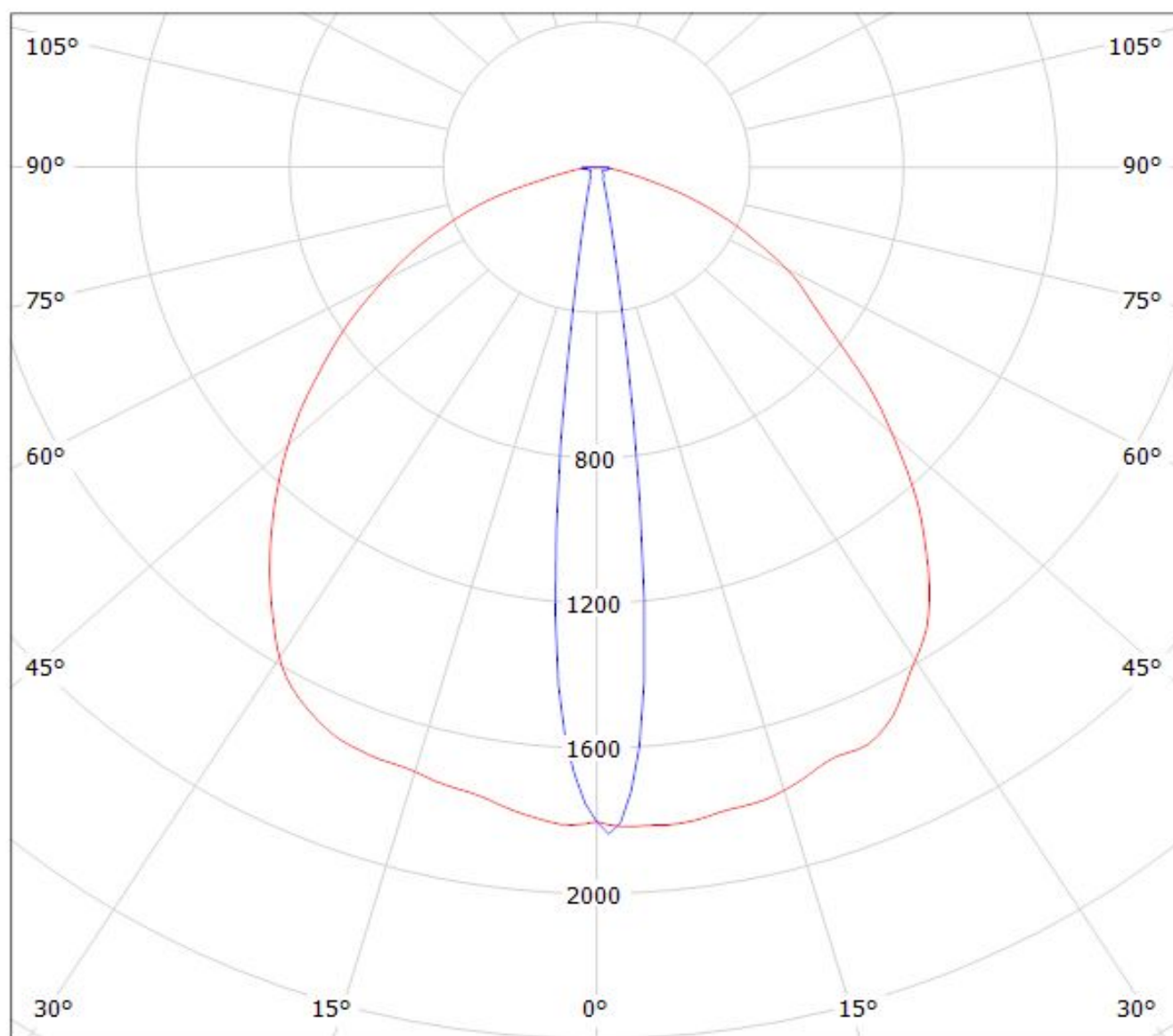

cd/klm

$\eta = 92\%$

— C0 - C180    — C90 - C270

Luminaire: Ledil Oy C13012\_FLARE-MAXI-D (Luxeon M 342lm @250mA) Efficiency=94%  
Lamps: 1 x Luxeon M 342lm @250mA

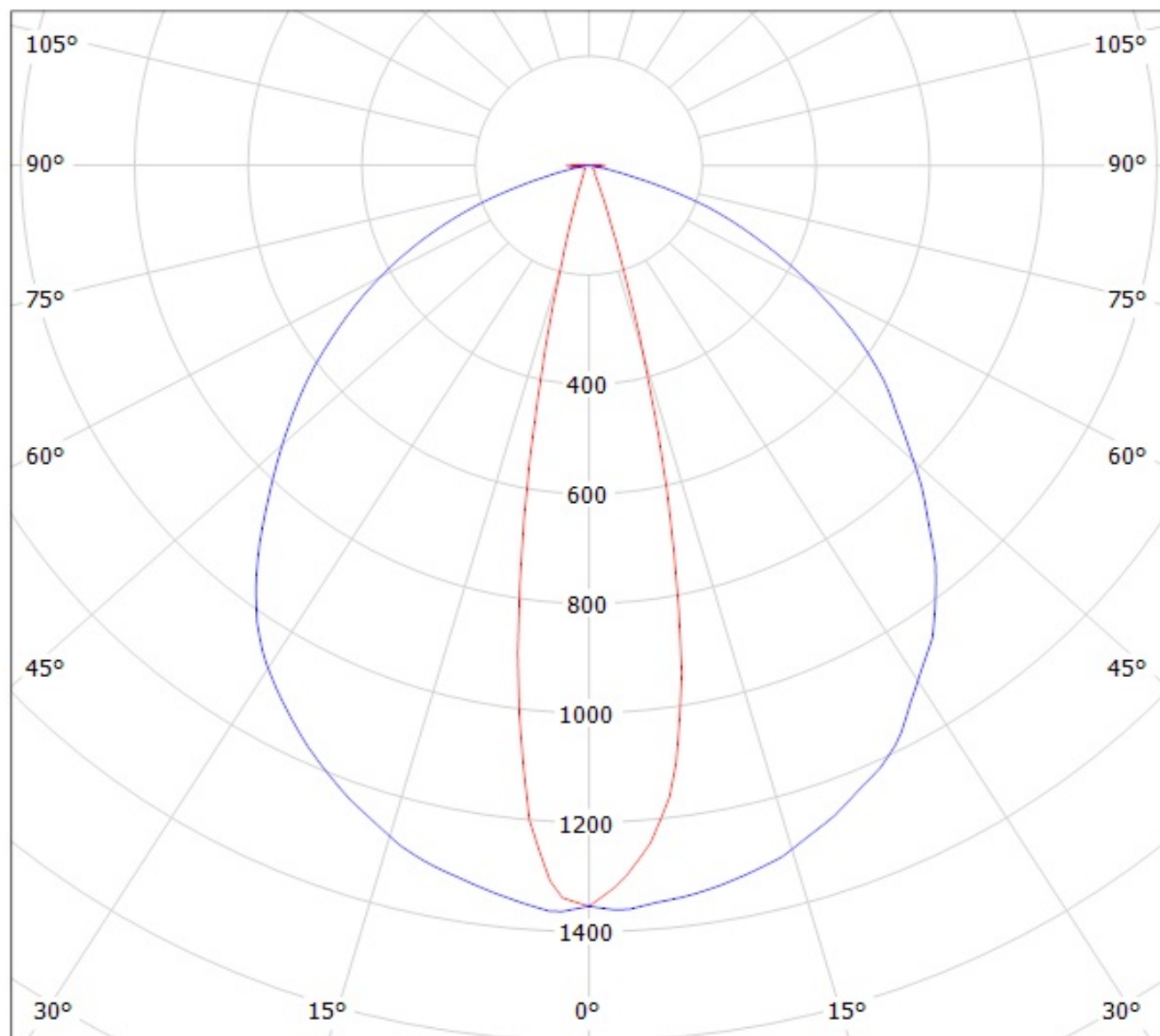

cd/klm

— C0 - C180

— C90 - C270



Luminaire: LEDiL Oy C13012\_FLARE-MAXI-D\_(Luxeon\_TX)

Lamps: 1 x Luxeon\_TX\_(L1T2-3585)\_80.1801lm@250mA\_CCT=3500K\_P=0.731482W\_I=249.9mA

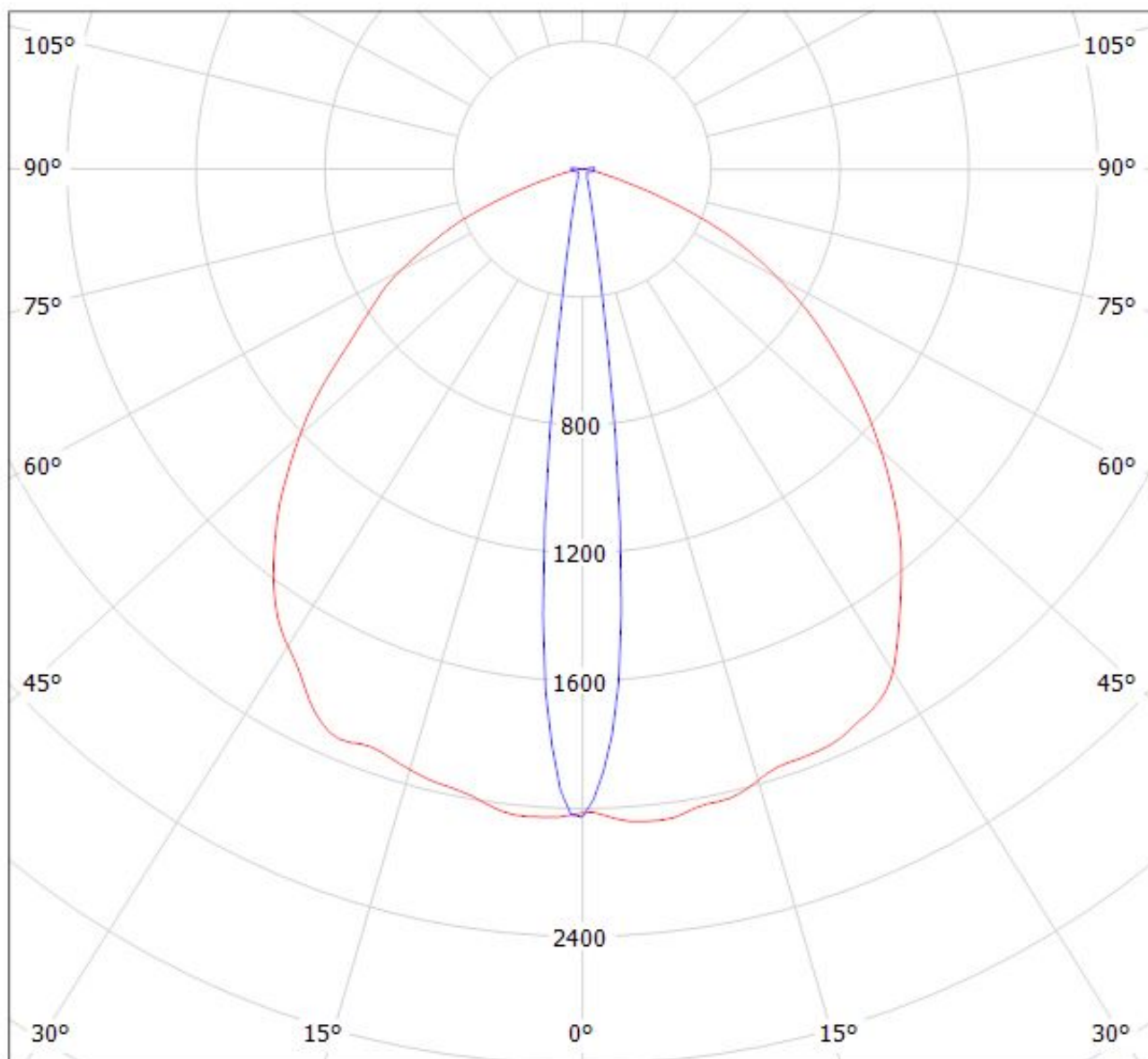

cd/klm

$\eta = 93\%$

— C0 - C180    — C90 - C270

Luminaire: LEDil Oy C13012\_FLARE-MAXI-D\_(Z5M1) Efficiency=94%

Lamps: 1 x Seoul Z5M1 (SZ5M1-W0-C8/W1-A5-G) 108lm @ 250mA CCT=9100K P=0.8W I=250mA

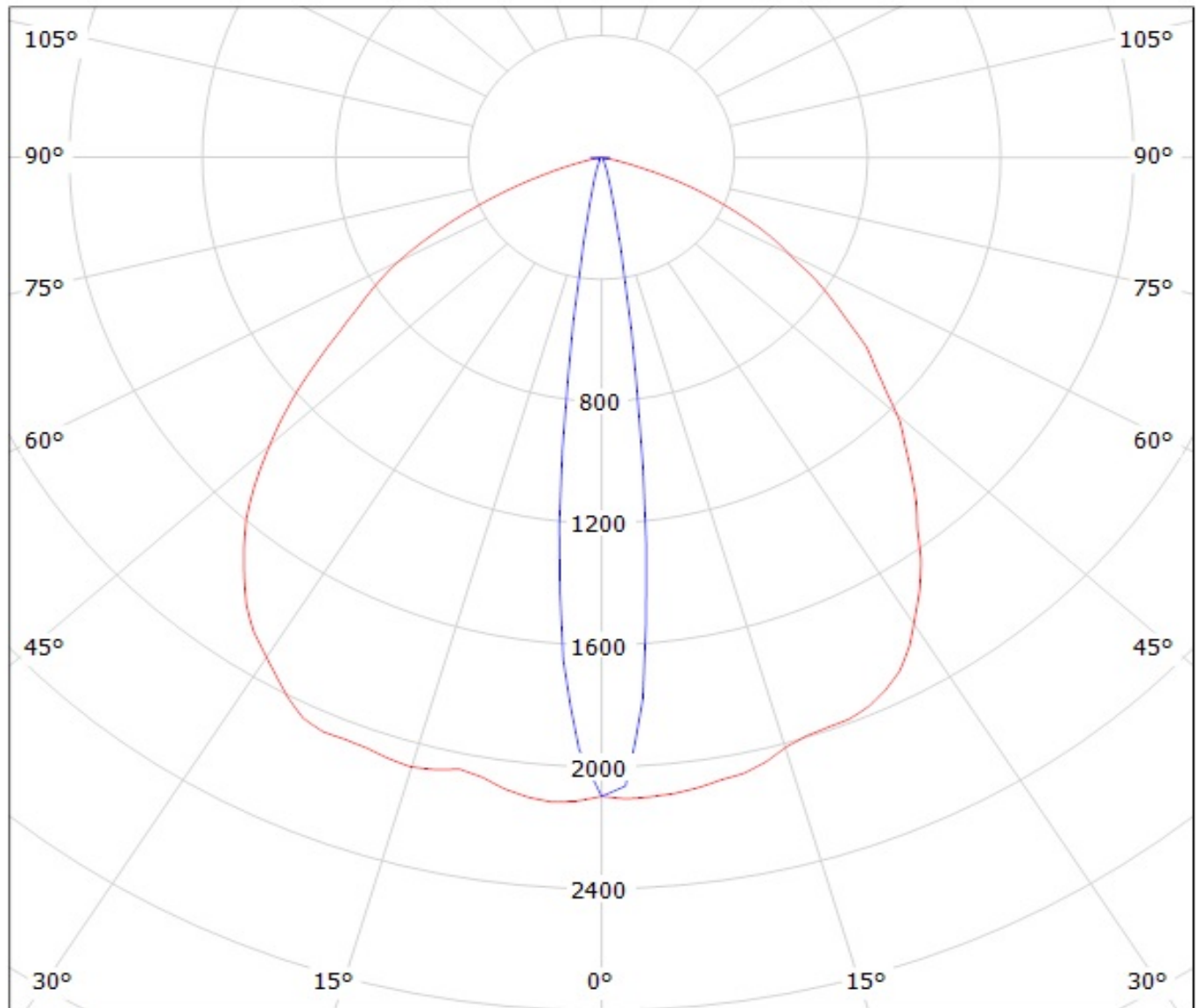

cd/klm

— C0 - C180

— C90 - C270



Luminaire: Ledil oy C13012\_FLARE-MAXI-D (Luxeon A 64lm @ 250mA) Efficiency=94%  
Lamps: 1 x Luxeon A 64lm @ 250mA

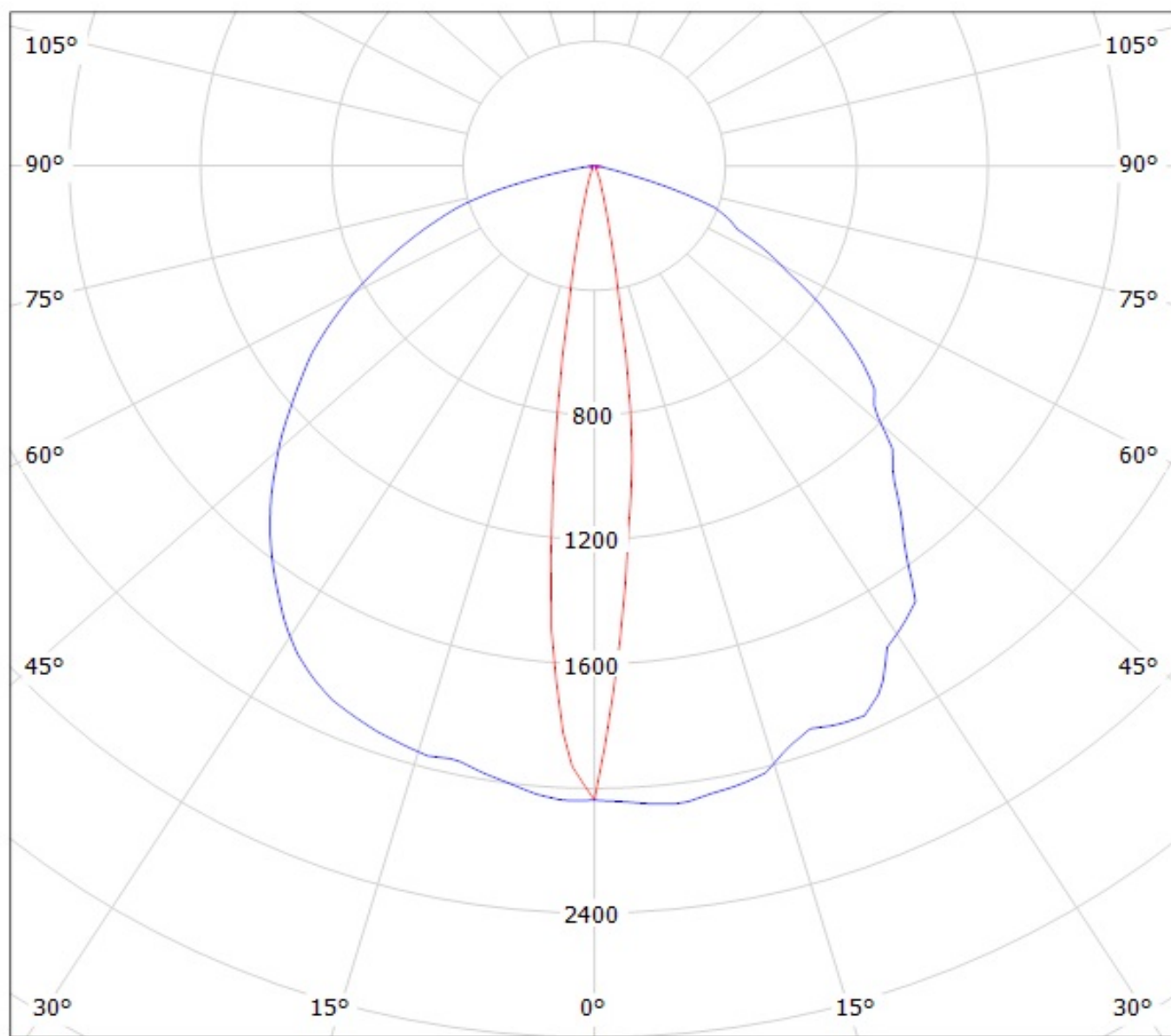

cd/klm

— C0 - C180

— C90 - C270

Luminaire: Ledil Oy C13012\_FLARE-MAXI-D (Osram Square PC 88lm @ 250mA) Efficiency=94%  
Lamps: 1 x Osram Square PC 88lm @ 250mA

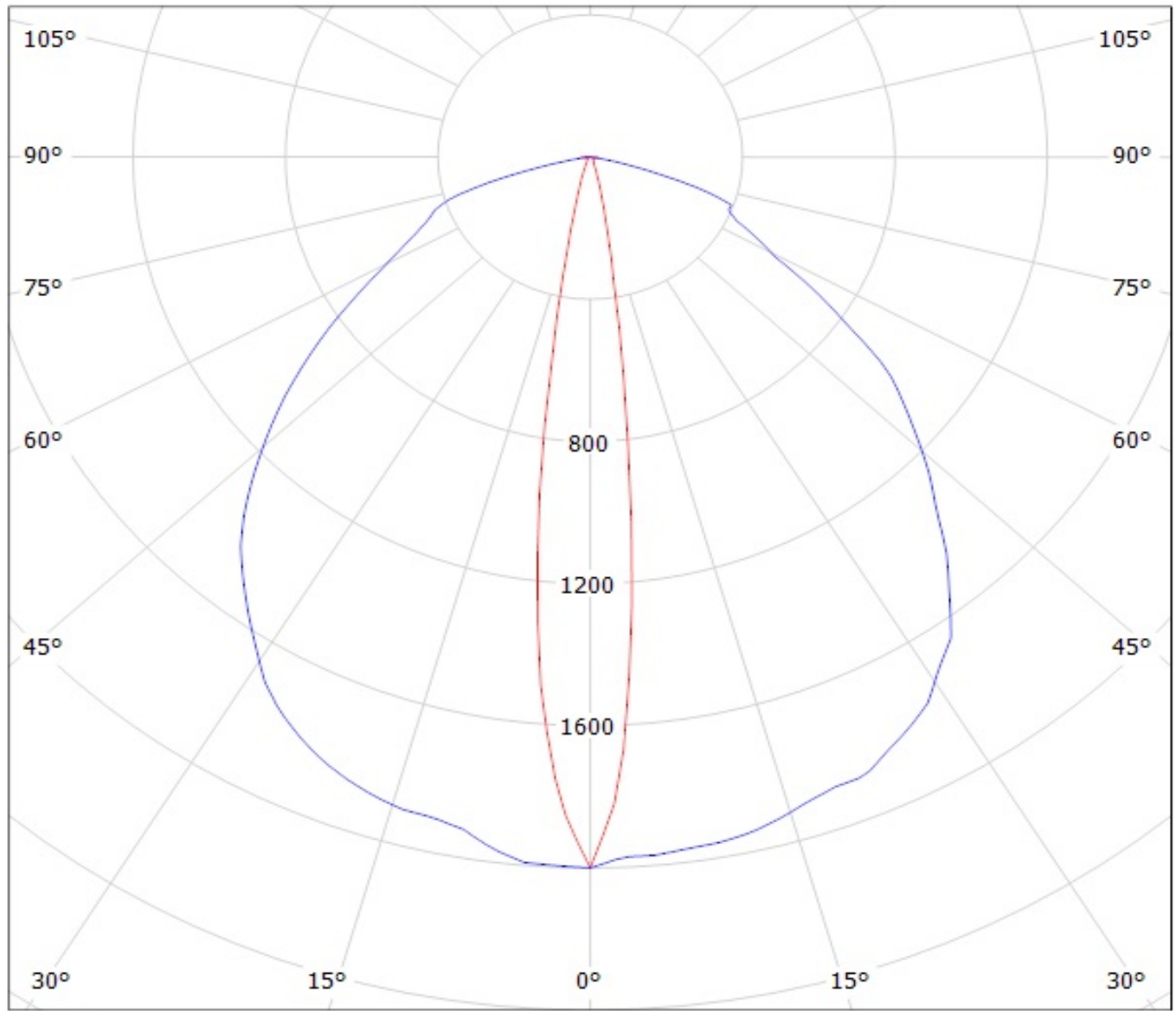

cd/klm  
— C0 - C180    — C90 - C270

Luminaire: Ledil Oy C13012\_FLARE-MAXI-D (Luxeon RE-ES 92lm @ 250mA) Efficiency=94%  
Lamps: 1 x Luxeon RE-ES 92lm @ 250mA

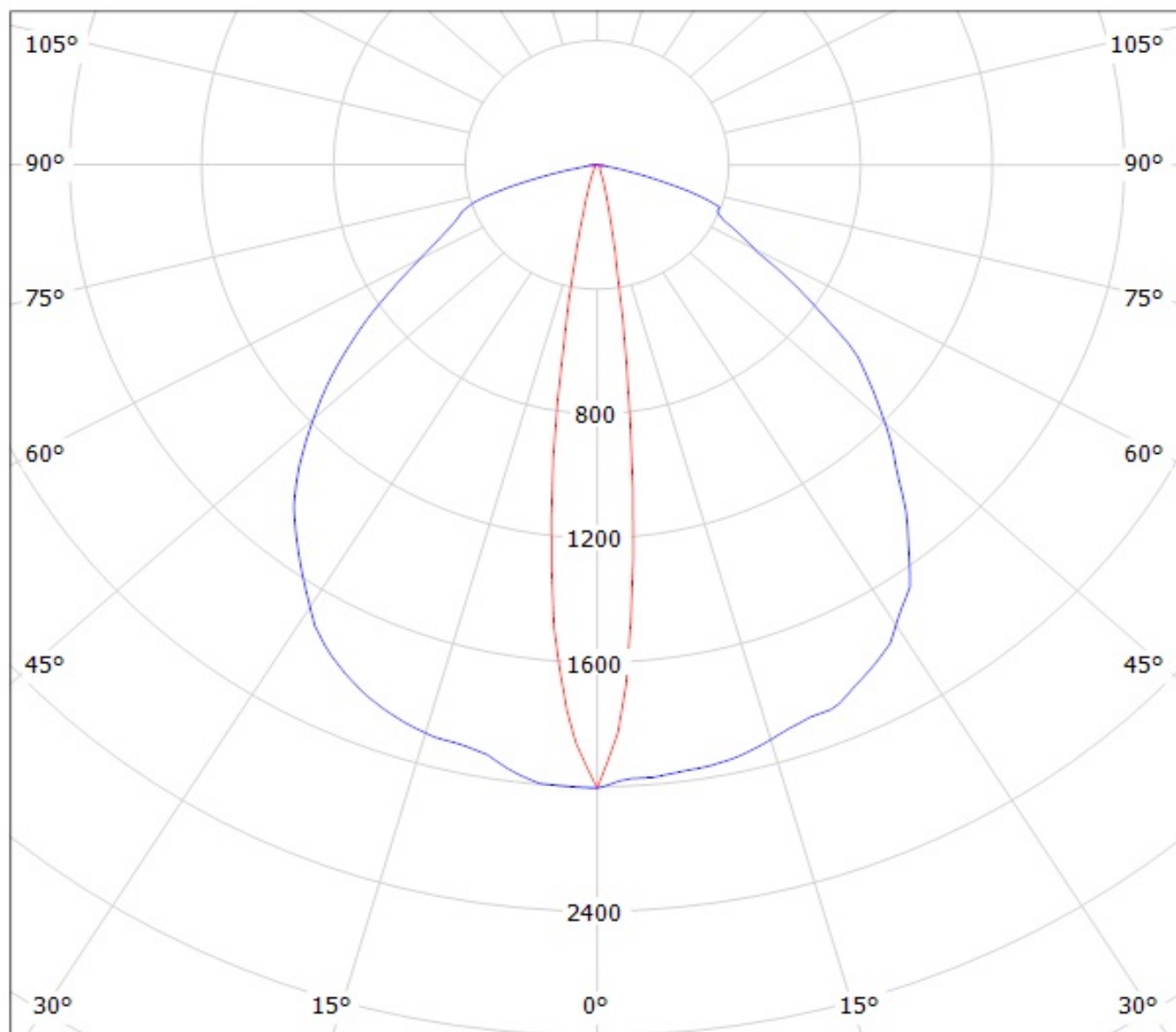

cd/klm

— C0 - C180

— C90 - C270

Luminaire: Ledil Oy C13012\_FLARE-MAXI-D (Cree XP-G2 98lm @ 250mA) Efficiency=94%  
Lamps: 1 x Cree XP-G2 98lm @ 250mA CCT=6596K P=0,75W I=250mA

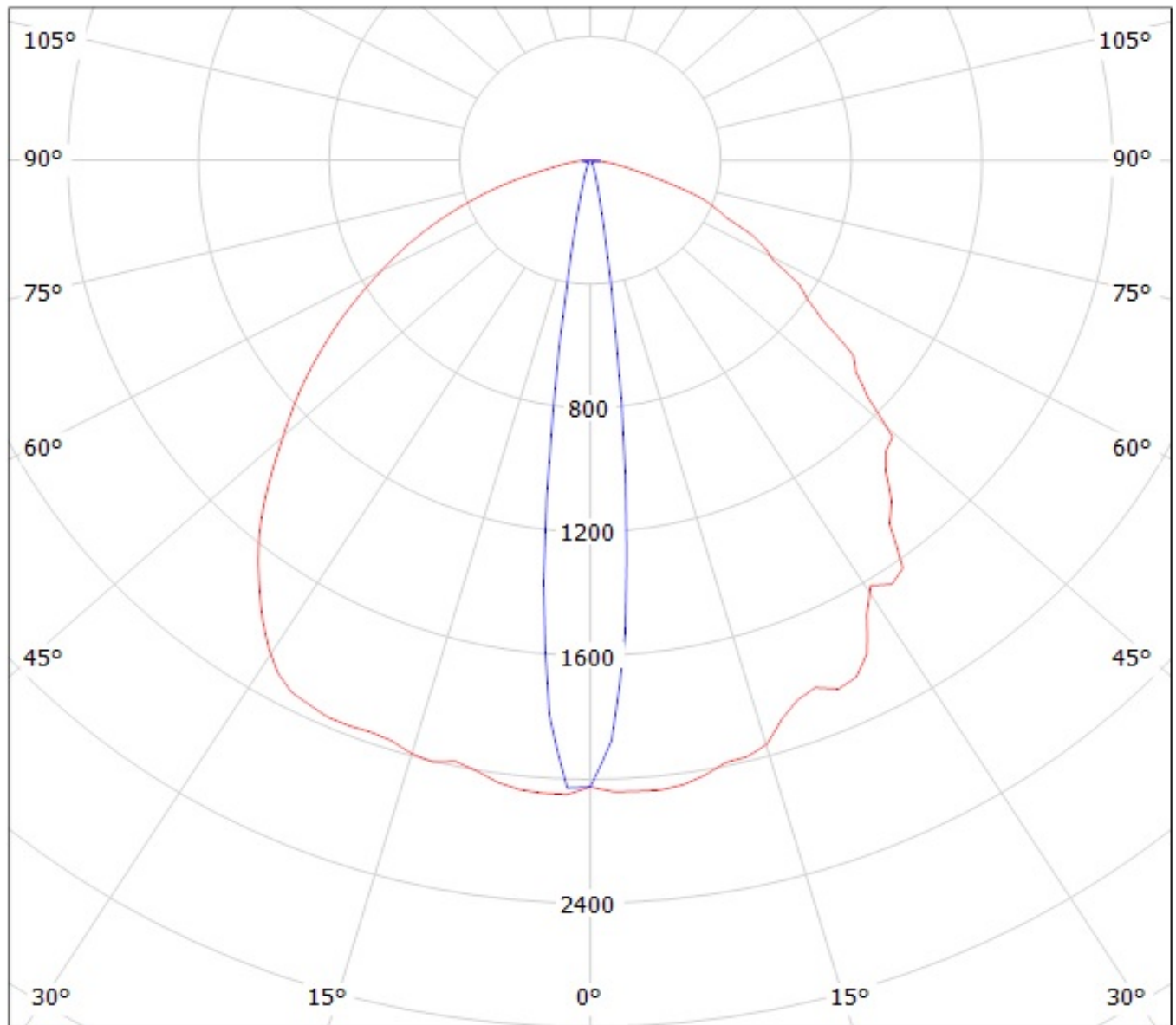

cd/klm

— C0 - C180    — C90 - C270

Luminaire: Ledil Oy C13012\_FLARE-MAXI-D\_(NCSxx19B) Efficiency=94%  
Lamps: 1 x Nichia NSCxx19B (NCSL119BE) 88lm @ 250mA CCT=3000K P=0.8W I=250mA

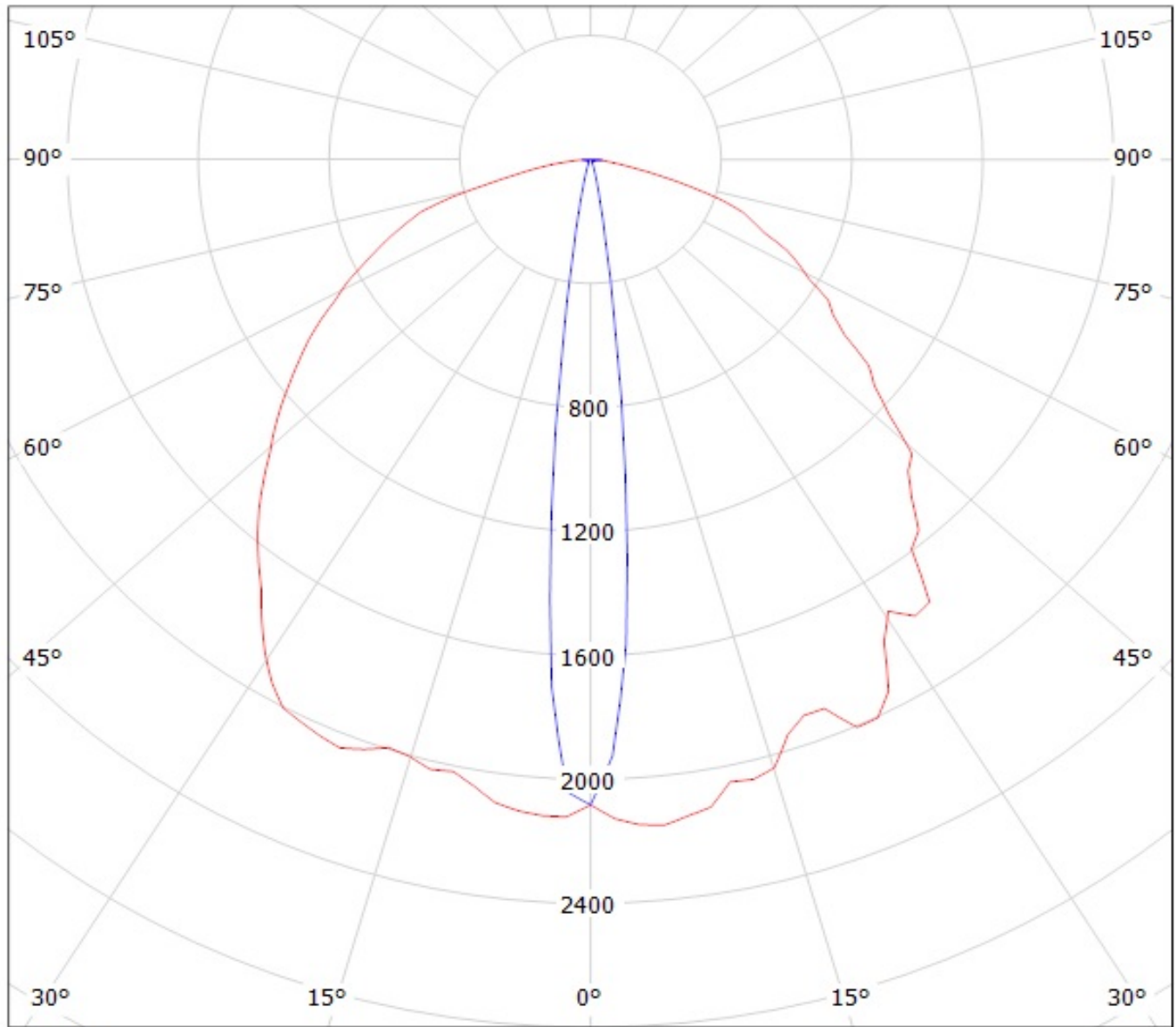

cd/klm  
— C0 - C180 — C90 - C270

Luminaire: Ledil Oy C13012\_FLARE-MAXI-D (Cree XM-L 97lm @ 250mA) Efficiency=94%  
Lamps: 1 x Cree XM-L 97lm @ 250mA

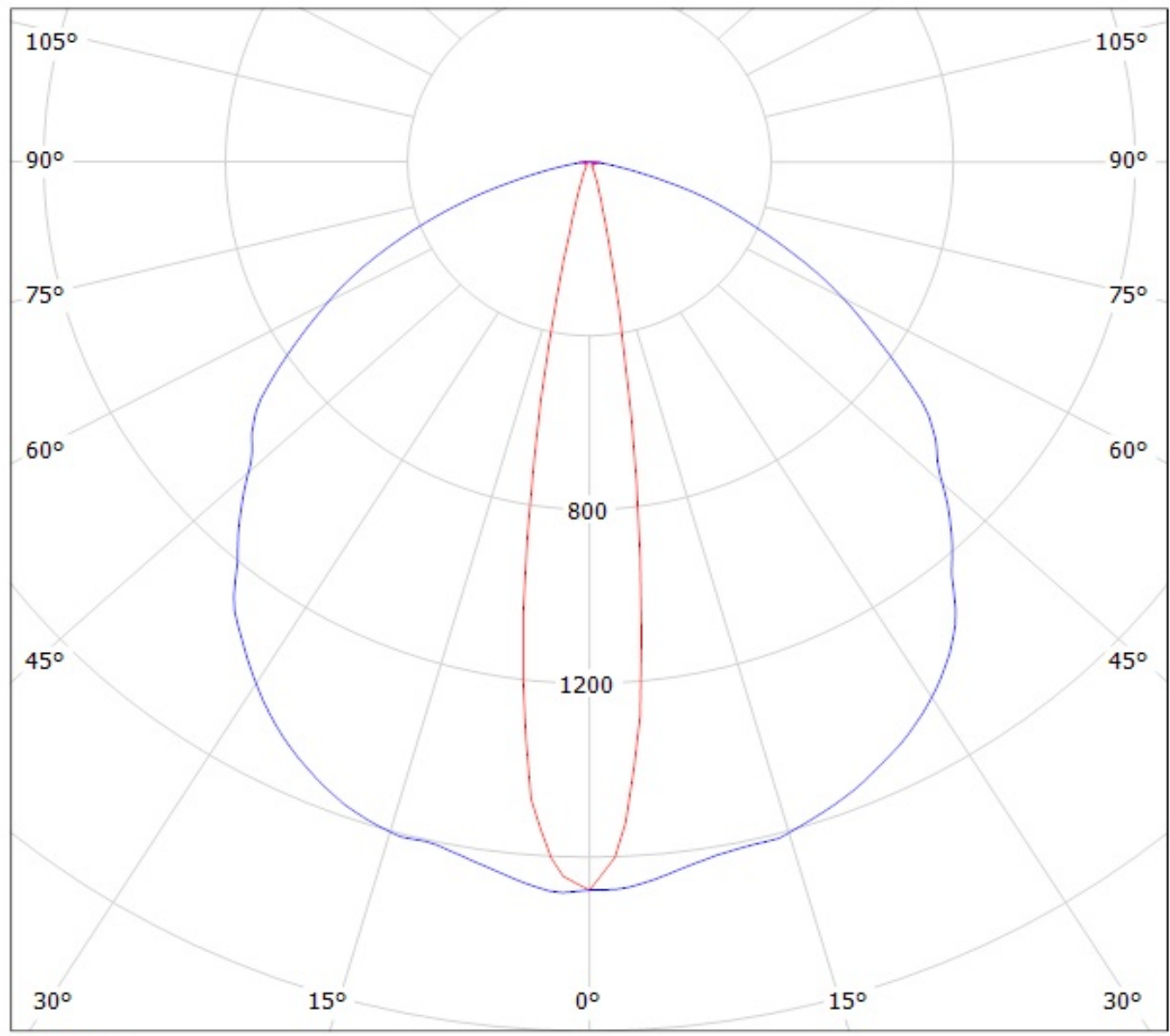

cd/klm

— C0 - C180

— C90 - C270



Luminaire: LEDiL Oy C13012\_FLARE-MAXI-D Eff.93.2%  
Lamps: 1 x Nichia NS9x383(107.656lm@250mA)

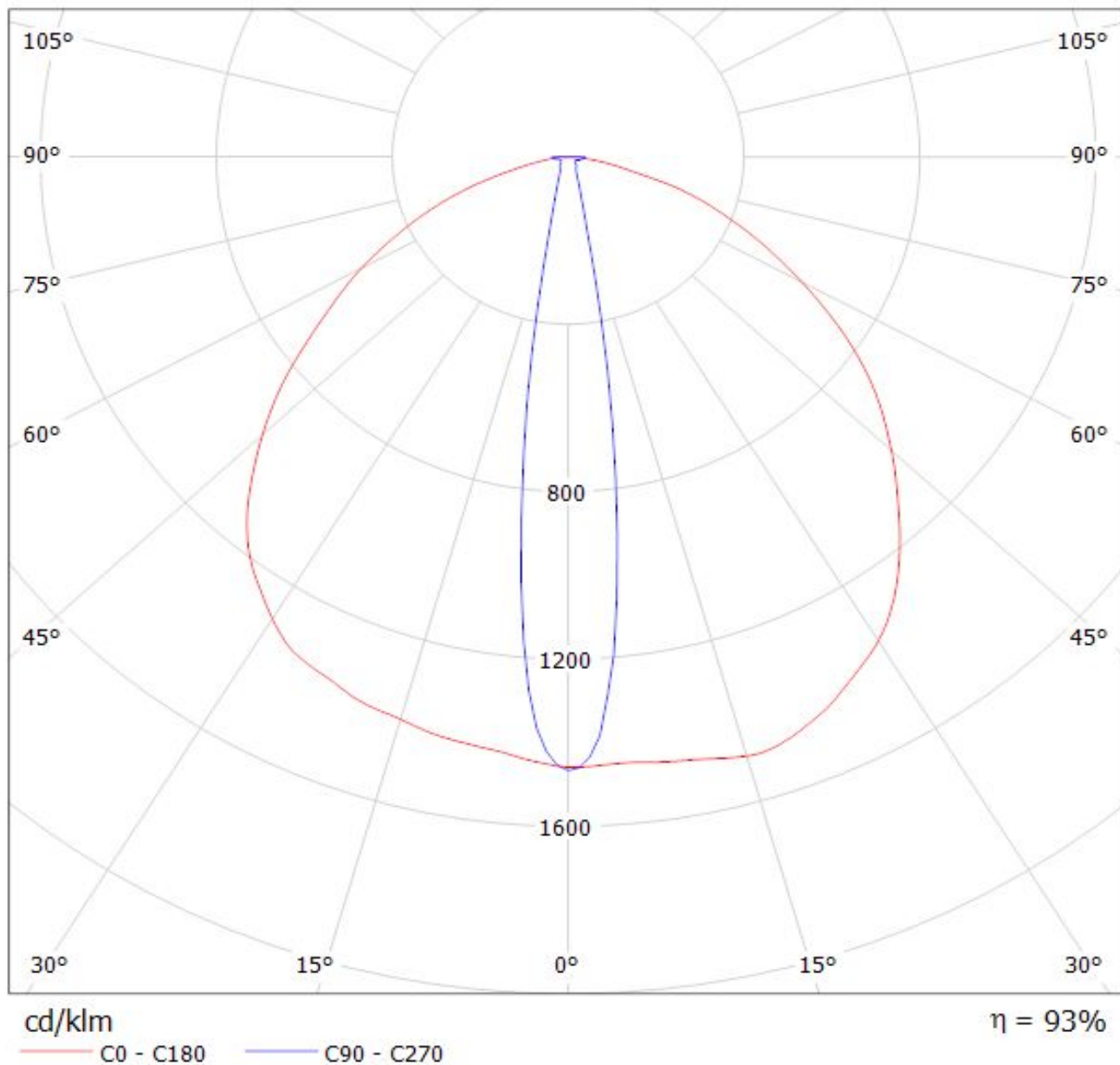

Luminaire: Ledil Oy C13012\_FLARE-MAXI-D (Cree XP-G 70lm @ 250mA) Efficiency=94%  
Lamps: 1 x Cree XP-G 70lm @ 250mA

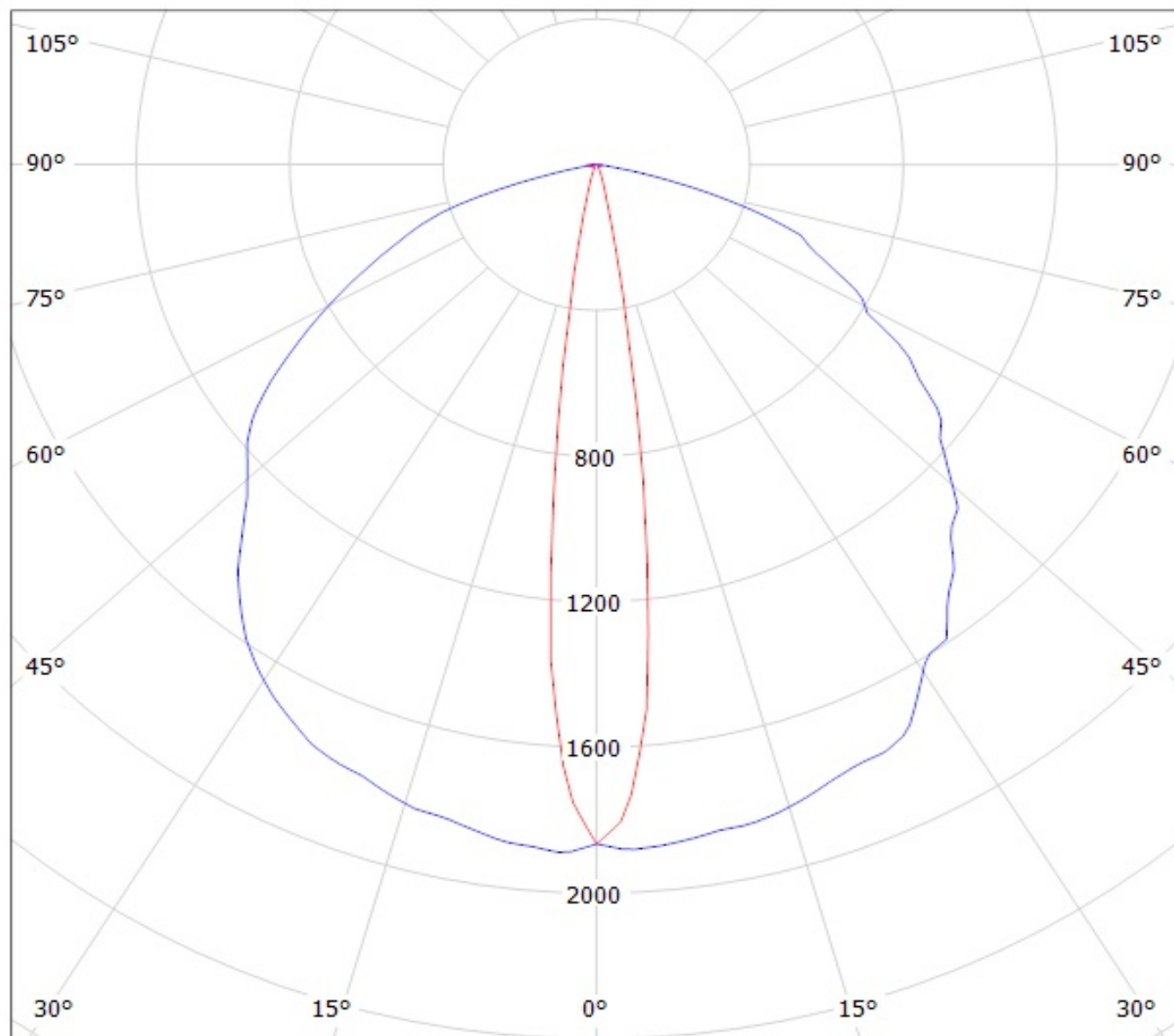

cd/klm

— C0 - C180

— C90 - C270



Luminaire: Ledil Oy C13012\_FLARE-MAXI-D (Nichia 219B 103lm @ 250mA) Efficiency=94%  
Lamps: 1 x Nichia 219B 103lm @ 250mA

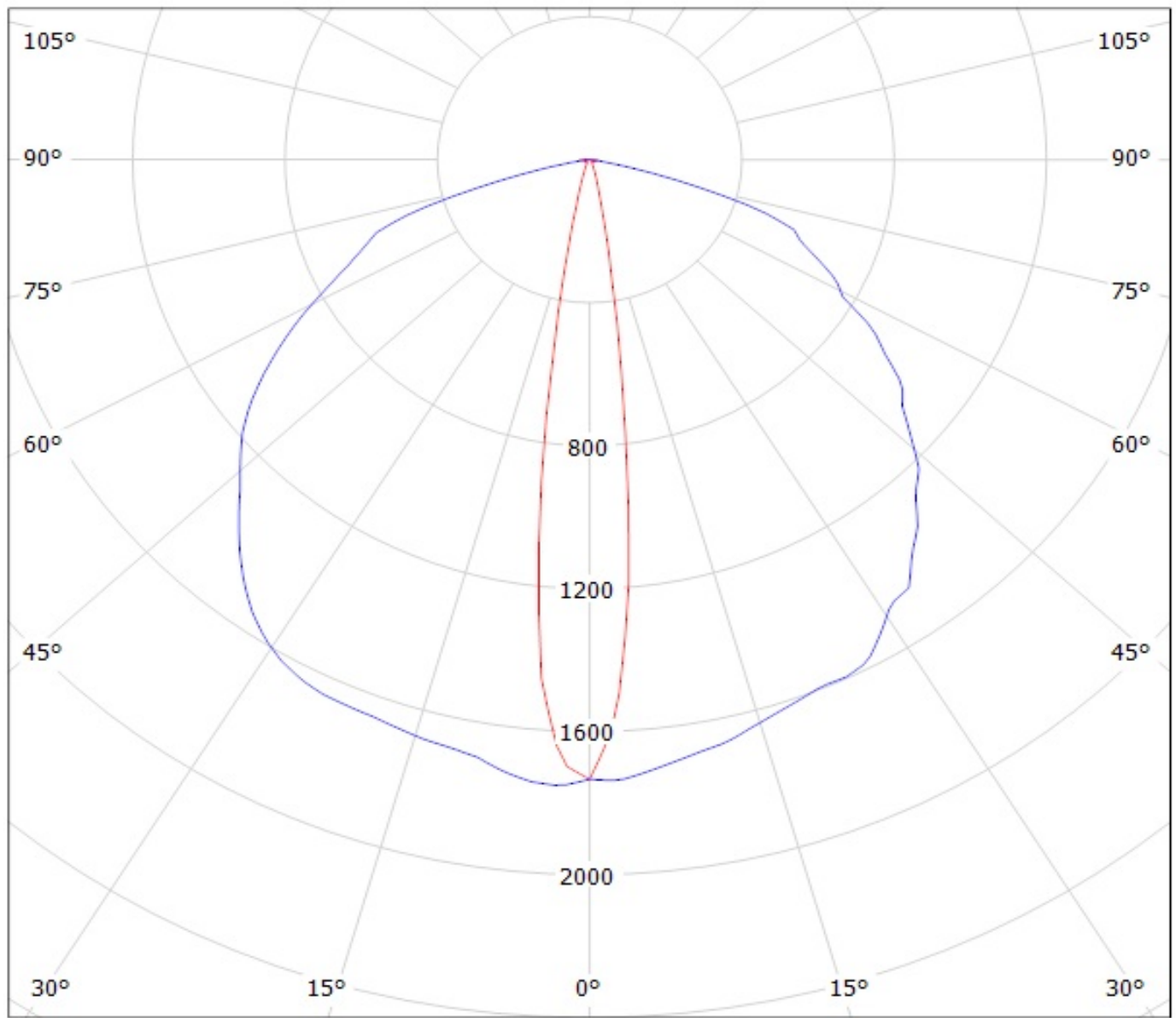

cd/klm

— C0 - C180

— C90 - C270

Luminaire: Ledil Oy C13012\_FLARE-MAXI-D (Cree XT-E 98lm @ 250mA) Efficiency=94%  
Lamps: 1 x Cree XT-E 98lm @ 250mA

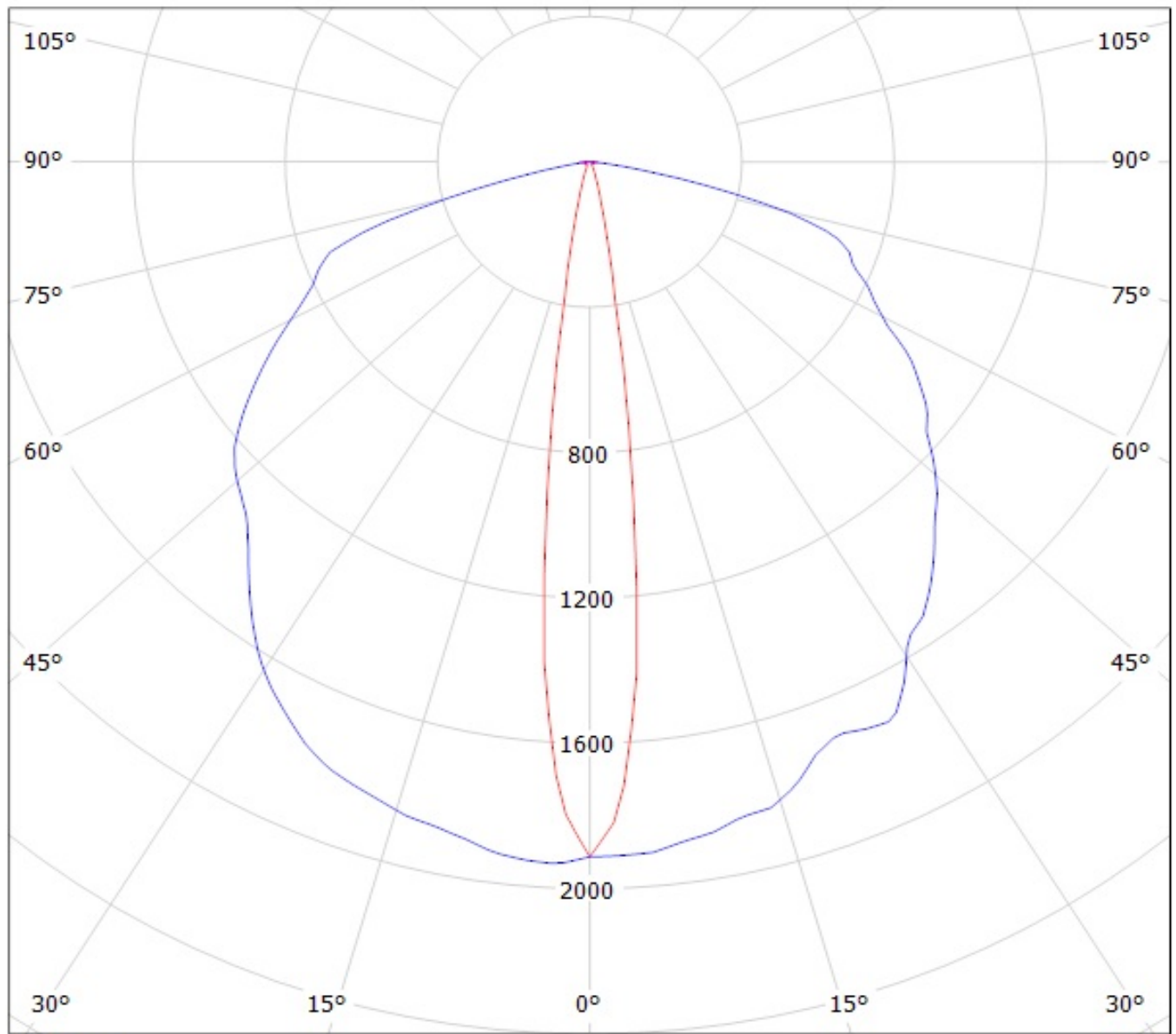

cd/klm

— C0 - C180

— C90 - C270

Luminaire: LEDiL Oy C13012\_FLARE-MAXI-D\_(XP-L)  
Lamps: 1 x Cree\_XP-L\_130lm@250mA\_P=0.73723W\_I=249.9mA

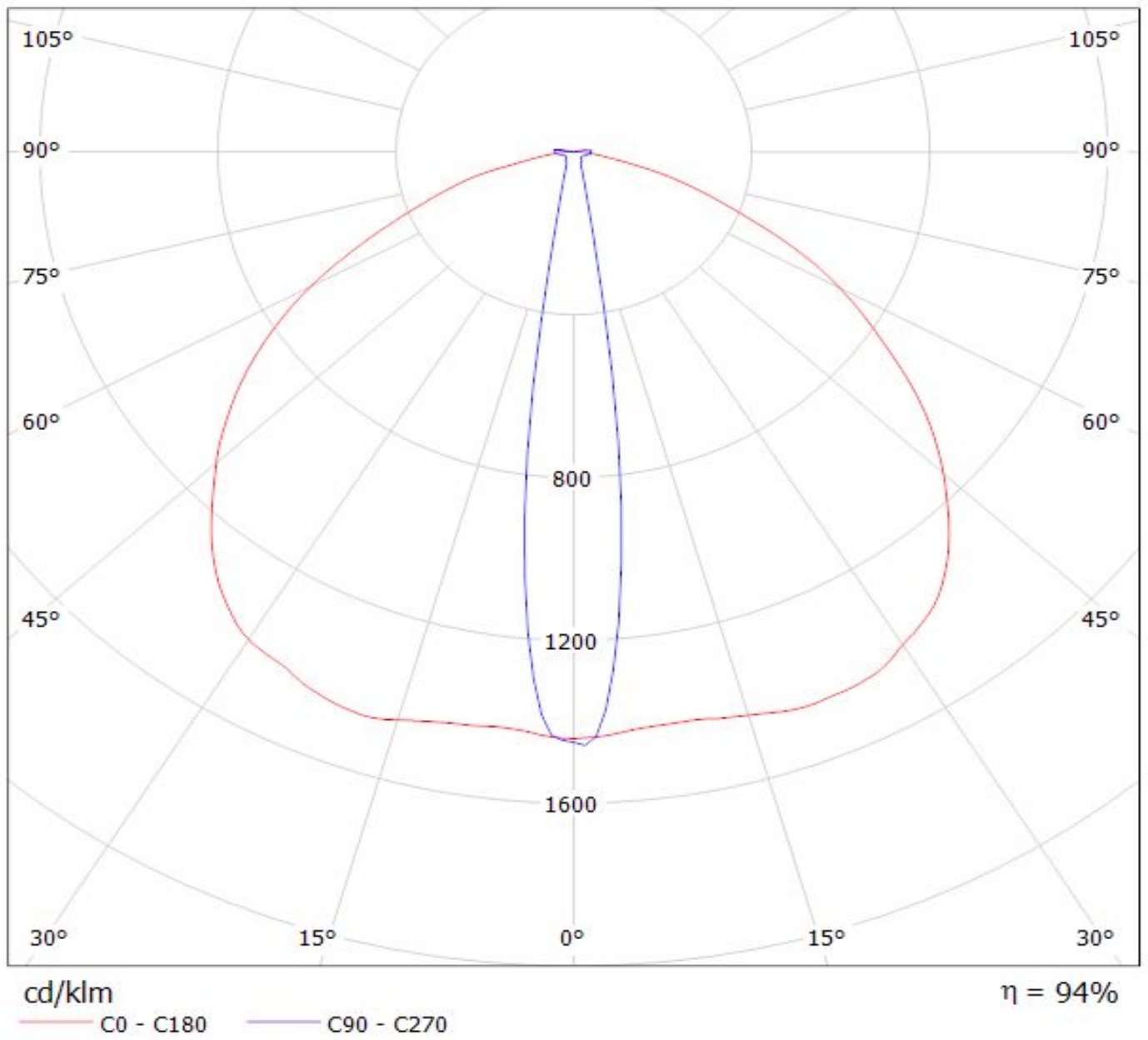

Luminaire: LEDil Oy C13012\_FLARE-MAXI-D\_(Oslon\_SSL\_150)  
Lamps: 1 x Osram Oslon SSL 150 (78.52lm @ 250mA) P=0.7W I=250mA

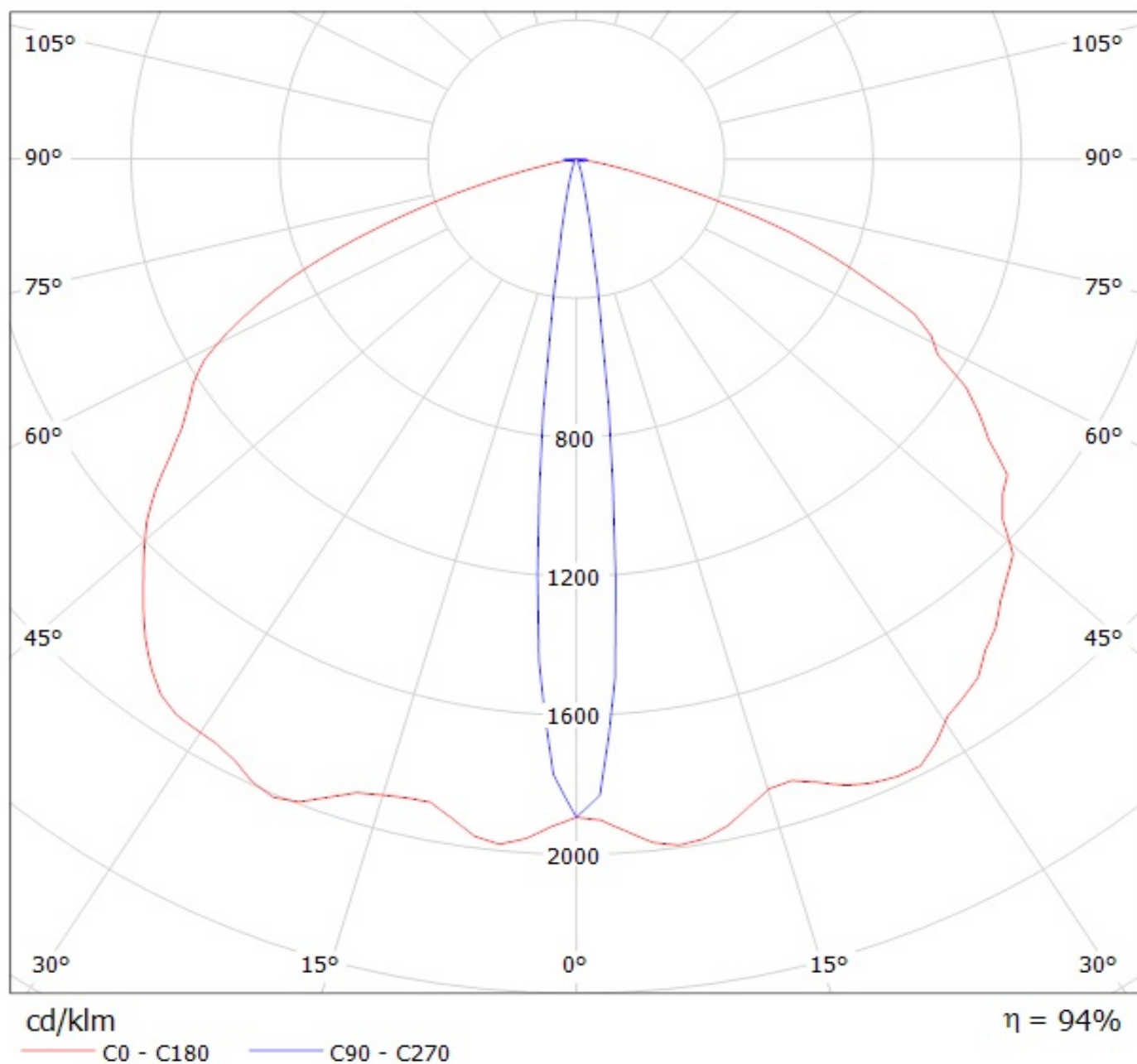

**NOTE: The typical divergence will be changed by different color, chip size and chip position tolerance. The typical total divergence is the full angle measured where the luminous intensity is half of the peak value.**